

# WELIGHTING

SHINE IN A BRIGHTER WAY

WELIGHTING ARCHITECTURAL LIGHTING SERIES

| LED STRIPS  
Customizable Linear Luminaire

| Flexi-Glow  
Extruded Silicone Strip

| Ray-Glow  
Extruded Aluminum Channel

01

# LED STRIPS

Customizable Linear Luminaire

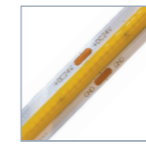

**COB LED Strip**

4



**ECO Strip**

6



**ECO S Strip**

8



**Extra Long LED Strip**

10



**Free Cut Strip**

12



**HE Strip**

14



**RGBW Strip**

16



**Tunable White Strip**

18

# COB LED Strip

- Seamless continuous light with no 'light dot'
- 3M self-adhesive double-sided tape attached
- Water-proof silicone jacket for IP65 version
- Customized length available on request
- Remote driver, separate order
- Water-proof silicone jacket for IP65 version



IP20

**WE X61090 - 90**

| CRI | CCT   | Power | Length |
|-----|-------|-------|--------|
| 27  | 2700K | 4W    | 90mm   |
| 30  | 3000K | 10W   | 90mm   |
| 40  | 4000K | 14W   | 90mm   |

SMD 24V DC Ra90+ 10W/m 950lm/m (3000K)

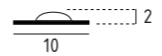

IP65 with silicone jacket

**WE X61091 - 90**

| CRI | CCT   | Power | Length |
|-----|-------|-------|--------|
| 27  | 2700K | 4W    | 90mm   |
| 30  | 3000K | 10W   | 90mm   |
| 40  | 4000K | 14W   | 90mm   |

SMD 24V DC Ra90+ 10W/m 950lm/m (3000K)

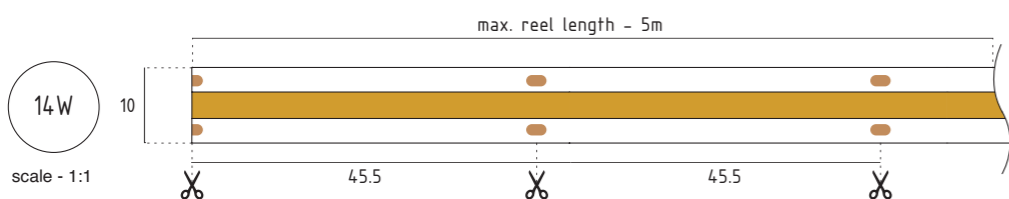
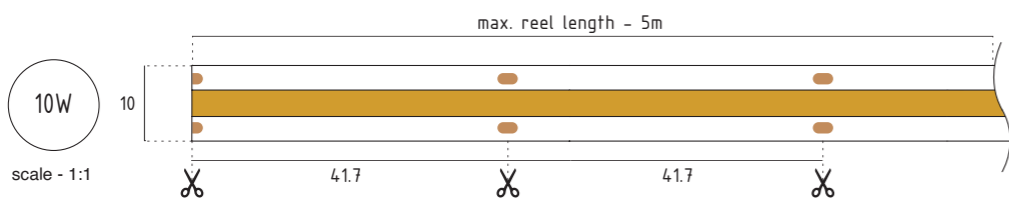
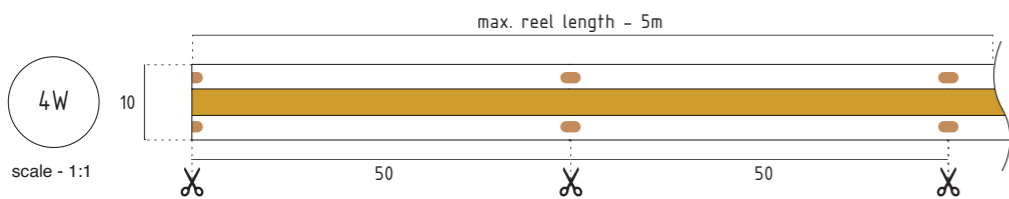
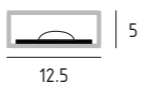

## Connetion Guideline

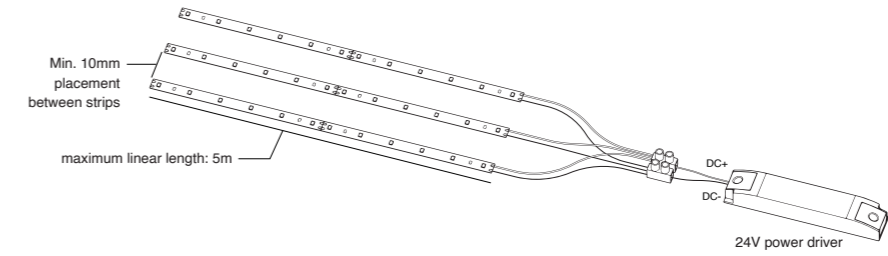

## Accessories

LED Strip Plastic Profile only compatible with IP65 version with silicone jacket

### WE MP1001-PM

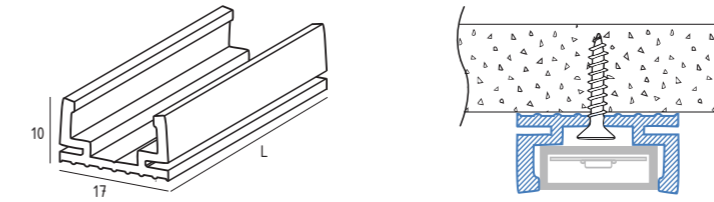

## Photometric Diagram

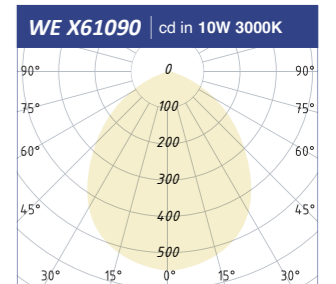

## Compatible LED Driver

| Order Code                      | Effective Power | Output                | Wiring Box Dimensions<br>L x W x H (mm) | Required Cut Hole<br>(mm) |
|---------------------------------|-----------------|-----------------------|---|---------------------------|
| <b>TD OS-24V-60N-ELV1(12A)</b>  | Max. 48W        | 24V                   | 320 x 90 x 40                           | ø98                       |
| <b>TD OS-24V-120N-ELV2(12A)</b> | Max. 96W        | 24V                   | 320 x 90 x 40                           | ø98                       |
| <b>TD LT-24V-75A-LMV2(12A)</b>  | Max. 60W        | 24V<br>0-10V dimmable | 320 x 90 x 40                           | ø98                       |
| <b>TD LT-24V-150A-LMV3(13A)</b> | Max. 120W       | 24V<br>0-10V dimmable | 360 x 90 x 40                           | ø98                       |

# ECO Strip

- 3M self-adhesive double-sided tape attached
- Water-proof silicone jacket for IP65 version
- Customized length available on request
- Remote driver, separate order



IP20

**WE L61010 - 90** - Length in mm

| CCT       | Power      |
|-----------|------------|
| 2 4 2400K | 4.8 4.8W   |
| 2 7 2700K | 9.6 9.6W   |
| 3 0 3000K | 14.4 14.4W |
| 3 5 3500K |            |
| 4 0 4000K |            |

SMD 24V DC Ra90+ 120pcs LED/m 14.4W/m 1296lm/m (3000K)

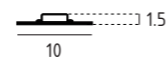

IP65 with silicone jacket

**WE L61011 - 90** - Length in mm

| CCT       | Power      |
|-----------|------------|
| 2 4 2400K | 4.8 4.8W   |
| 2 7 2700K | 9.6 9.6W   |
| 3 0 3000K | 14.4 14.4W |
| 3 5 3500K |            |
| 4 0 4000K |            |

SMD 24V DC Ra90+ 120pcs LED/m 14.4W/m 1296lm/m (3000K)

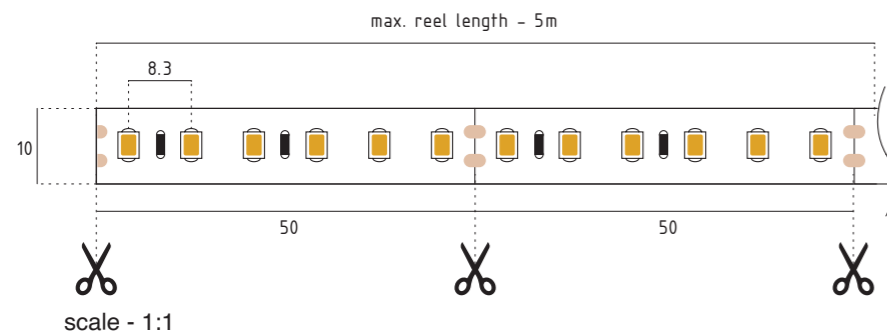
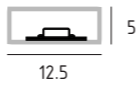

## Connetion Guideline

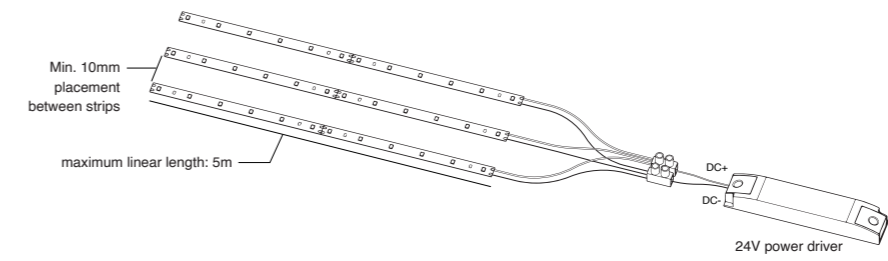

## Accessories

LED Strip Plastic Profile only compatible with IP65 version with silicone jacket

### WE MP1001-PM

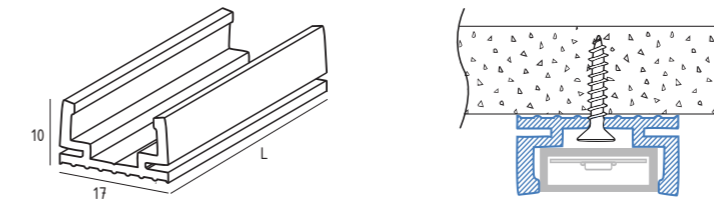

## Photometric Diagram

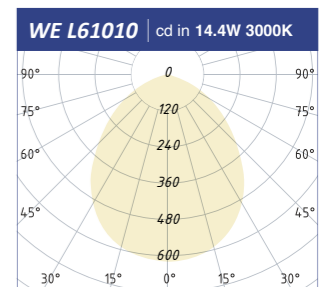

## Compatible LED Driver

| Order Code                      | Effective Power | Output                | Wiring Box Dimensions<br>L x W x H (mm) | Required Cut Hole<br>(mm) |
|---------------------------------|-----------------|-----------------------|---|---------------------------|
| <b>TD OS-24V-60N-ELV1(12A)</b>  | Max. 48W        | 24V                   | 320 x 90 x 40                           | ø98                       |
| <b>TD OS-24V-120N-ELV2(12A)</b> | Max. 96W        | 24V                   | 320 x 90 x 40                           | ø98                       |
| <b>TD LT-24V-75A-LMV2(12A)</b>  | Max. 60W        | 24V<br>0-10V dimmable | 320 x 90 x 40                           | ø98                       |
| <b>TD LT-24V-150A-LMV3(13A)</b> | Max. 120W       | 24V<br>0-10V dimmable | 360 x 90 x 40                           | ø98                       |



# ECO S Strip

- 3M self-adhesive double-sided tape attached
- Water-proof silicone jacket for IP65 version
- Customized length available on request
- Remote driver, separate order



IP20

**WE L61087 - 90**

| CRI | CCT | Power | Length   |
|-----|-----|-------|----------|
| 2   | 4   | 2400K | 4.8 4.8W |
| 2   | 7   | 2700K | 9.6 9.6W |
| 3   | 0   | 3000K |          |
| 3   | 5   | 3500K |          |
| 4   | 0   | 4000K |          |

SMD 24V DC Ra90+ 60pcs LED/m 9.6W/m 864lm/m (3000K)

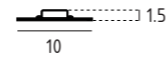

IP65 with silicone jacket

**WE L61088 - 90**

| CRI | CCT | Power | Length   |
|-----|-----|-------|----------|
| 2   | 4   | 2400K | 4.8 4.8W |
| 2   | 7   | 2700K | 9.6 9.6W |
| 3   | 0   | 3000K |          |
| 3   | 5   | 3500K |          |
| 4   | 0   | 4000K |          |

SMD 24V DC Ra90+ 60pcs LED/m 9.6W/m 864lm/m (3000K)

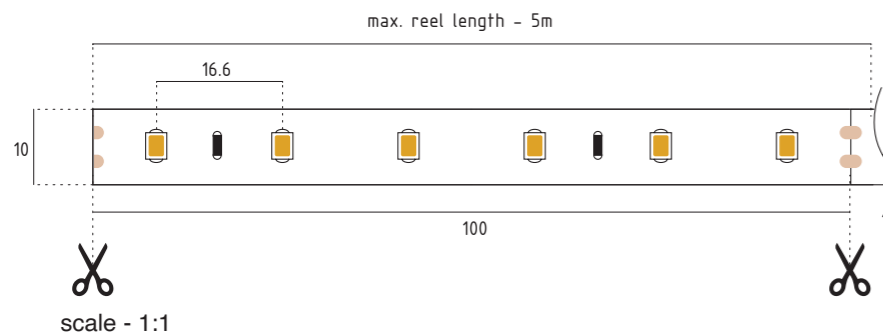
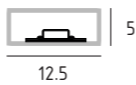

## Connetion Guideline

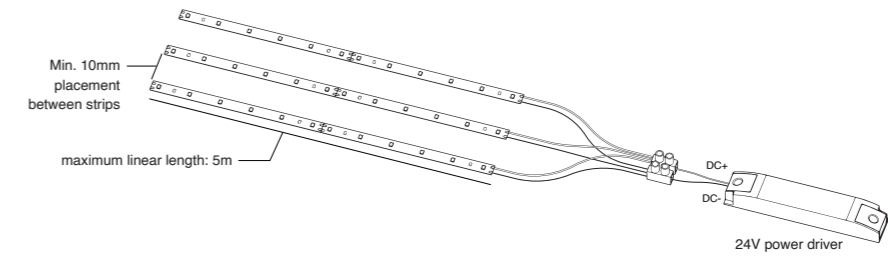

## Accessories

LED Strip Plastic Profile only compatible with IP65 version with silicone jacket

### WE MP1001-PM

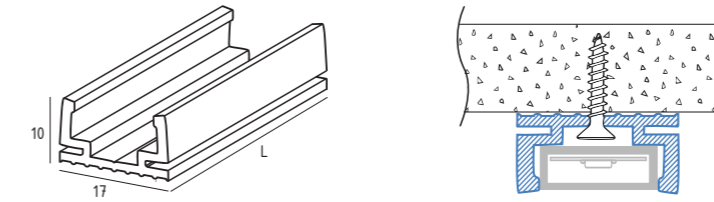

## Photometric Diagram

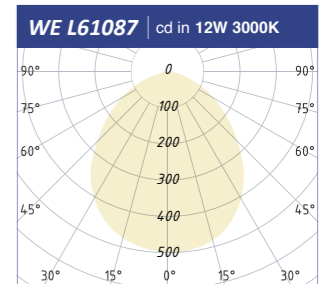

## Compatible LED Driver

| Order Code                      | Effective Power | Output                | Wiring Box Dimensions<br>L x W x H (mm) | Required Cut Hole<br>(mm) |
|---------------------------------|-----------------|-----------------------|---|---------------------------|
| <b>TD OS-24V-60N-ELV1(12A)</b>  | Max. 48W        | 24V                   | 320 x 90 x 40                           | ø98                       |
| <b>TD OS-24V-120N-ELV2(12A)</b> | Max. 96W        | 24V                   | 320 x 90 x 40                           | ø98                       |
| <b>TD LT-24V-75A-LMV2(12A)</b>  | Max. 60W        | 24V<br>0-10V dimmable | 320 x 90 x 40                           | ø98                       |
| <b>TD LT-24V-150A-LMV3(13A)</b> | Max. 120W       | 24V<br>0-10V dimmable | 360 x 90 x 40                           | ø98                       |

# Extra Long LED Strip

- Extra Long linear connection up to 22 meters
- 3M self-adhesive double-sided tape attached
- Water-proof silicone jacket for IP65 version
- Customized length available on request
- Remote driver, separate order



IP20

**WE L61093 - 90** - CCT - Power - Length in mm

| CCT   | Power |
|-------|-------|
| 2700K | 4.8W  |
| 3000K | 9.6W  |
| 3500K | 14.4W |
| 4000K |       |

SMD 24V DC Ra90+ 120pcs LED/m 9.6W/m 1062lm/m (3000K)

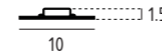

IP65 with silicone jacket

**WE L61094 - 90** - CCT - Power - Length in mm

| CCT   | Power |
|-------|-------|
| 2700K | 4.8W  |
| 3000K | 9.6W  |
| 3500K | 14.4W |
| 4000K |       |

SMD 24V DC Ra90+ 120pcs LED/m 9.6W/m 1062lm/m (3000K)

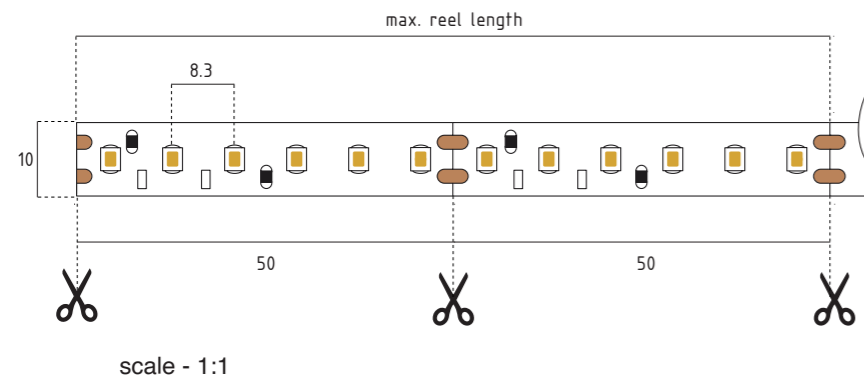
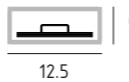

| Power | Max. Reel Length |
|-------|------------------|
| 4.8W  | 25 meter         |
| 9.6W  | 15 meter         |
| 14.4W | 10 meter         |

## Connection Guideline

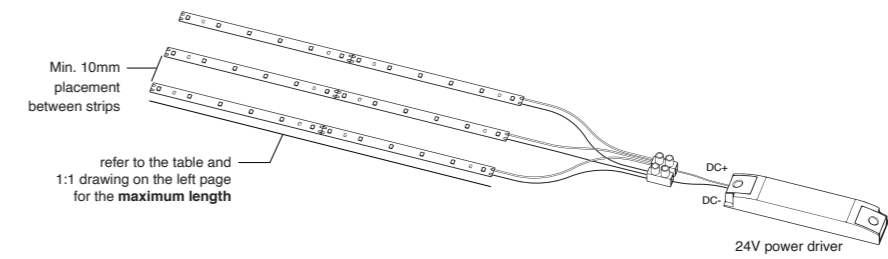

## Accessories

LED Strip Plastic Profile only compatible with IP65 version with silicone jacket

### WE MP1001-PM

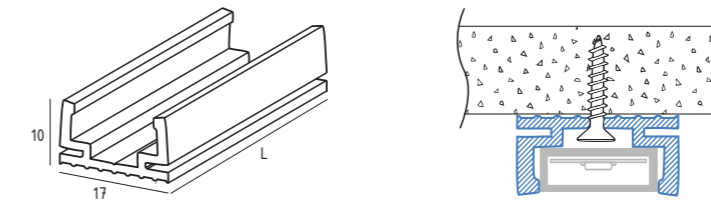

## Photometric Diagram

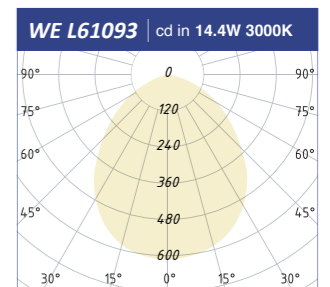

## Compatible LED Driver

| Order Code                      | Effective Power | Output                | Wiring Box Dimensions<br>L x W x H (mm) | Required Cut Hole<br>(mm) |
|---------------------------------|-----------------|-----------------------|---|---------------------------|
| <b>TD OS-24V-60N-ELV1(12A)</b>  | Max. 48W        | 24V                   | 320 x 90 x 40                           | ø98                       |
| <b>TD OS-24V-120N-ELV2(12A)</b> | Max. 96W        | 24V                   | 320 x 90 x 40                           | ø98                       |
| <b>TD LT-24V-75A-LMV2(12A)</b>  | Max. 60W        | 24V<br>0-10V dimmable | 320 x 90 x 40                           | ø98                       |
| <b>TD LT-24V-150A-LMV3(13A)</b> | Max. 120W       | 24V<br>0-10V dimmable | 360 x 90 x 40                           | ø98                       |

# Free Cut Strip

- Flexible cutting unit with a minimum unit of 8.3mm
- 3M self-adhesive double-sided tape attached
- Water-proof silicone jacket for IP65 version
- Customized length available on request
- Remote driver, separate order



IP20

**WE L61081 - 90** - Length in mm

| CRI | CCT | Power | Length |
|-----|-----|-------|--------|
| 2   | 7   | 2700K | 4.8    |
| 3   | 0   | 3000K | 9.6    |
| 3   | 5   | 3500K | 14.4   |
| 4   | 0   | 4000K |        |

| CCT   | Power |
|-------|-------|
| 2700K | 4.8W  |
| 3000K | 9.6W  |
| 3500K | 14.4W |
| 4000K |       |

SMD 24V DC Ra90+ 120pcs LED/m 14.4W/m 1161lm/m (3000K)

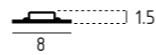

IP65 with silicone jacket

**WE L61082 - 90** - Length in mm

| CRI | CCT | Power | Length |
|-----|-----|-------|--------|
| 2   | 7   | 2700K | 4.8    |
| 3   | 0   | 3000K | 9.6    |
| 3   | 5   | 3500K | 14.4   |
| 4   | 0   | 4000K |        |

| CCT   | Power |
|-------|-------|
| 2700K | 4.8W  |
| 3000K | 9.6W  |
| 3500K | 14.4W |
| 4000K |       |

SMD 24V DC Ra90+ 120pcs LED/m 14.4W/m 1161lm/m (3000K)

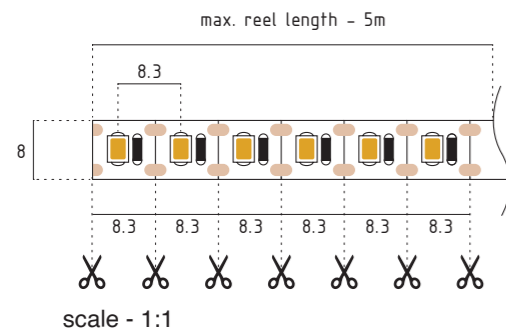
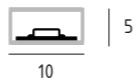

## Connetion Guideline

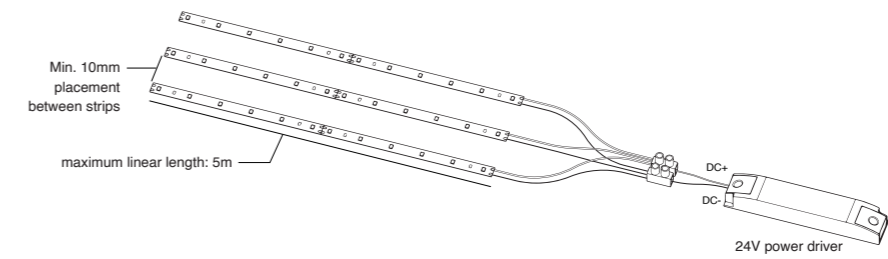

## Photometric Diagram

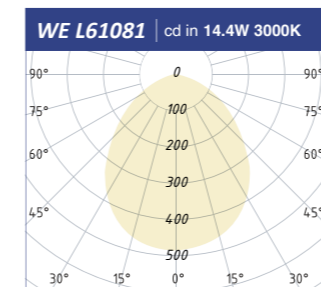

## Compatible LED Driver

| Order Code                      | Effective Power | Output                | Wiring Box Dimensions<br>L x W x H (mm) | Required Cut Hole<br>(mm) |
|---------------------------------|-----------------|-----------------------|---|---------------------------|
| <b>TD OS-24V-60N-ELV1(12A)</b>  | Max. 48W        | 24V                   | 320 x 90 x 40                           | ø98                       |
| <b>TD OS-24V-120N-ELV2(12A)</b> | Max. 96W        | 24V                   | 320 x 90 x 40                           | ø98                       |
| <b>TD LT-24V-75A-LMV2(12A)</b>  | Max. 60W        | 24V<br>0-10V dimmable | 320 x 90 x 40                           | ø98                       |
| <b>TD LT-24V-150A-LMV3(13A)</b> | Max. 120W       | 24V<br>0-10V dimmable | 360 x 90 x 40                           | ø98                       |

# HE Strip

- High efficacy linear LED strip
- 3M self-adhesive double-sided tape attached
- Water-proof silicone jacket for IP65 version
- Customized length available on request
- Remote driver, separate order



IP20

**WE L61075 - 90**

| CRI | CCT | Power | Length |
|-----|-----|-------|--------|
| 2   | 4   | 2400K | 4.8    |
| 2   | 7   | 2700K | 9.6    |
| 3   | 0   | 3000K | 14.4   |
| 3   | 5   | 3500K |        |
| 4   | 0   | 4000K |        |

SMD 24V DC Ra90+ 160pcs LED/m 14.4W/m 1597lm/m (3000K)

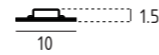

IP65 with silicone jacket

**WE L61076 - 90**

| CRI | CCT | Power | Length |
|-----|-----|-------|--------|
| 2   | 4   | 2400K | 4.8    |
| 2   | 7   | 2700K | 9.6    |
| 3   | 0   | 3000K | 14.4   |
| 3   | 5   | 3500K |        |
| 4   | 0   | 4000K |        |

SMD 24V DC Ra90+ 160pcs LED/m 14.4W/m 1597lm/m (3000K)

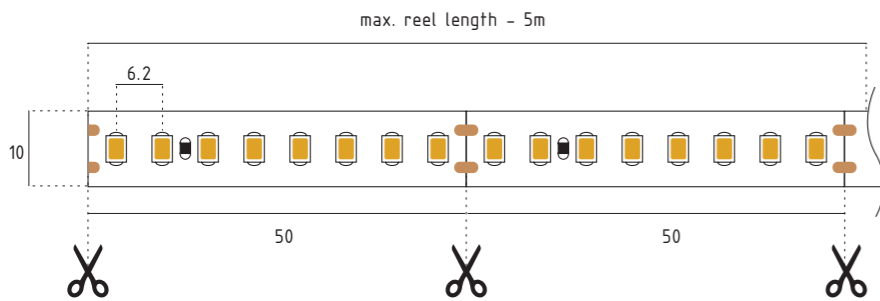
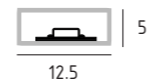

scale - 1:1

## Connetion Guideline

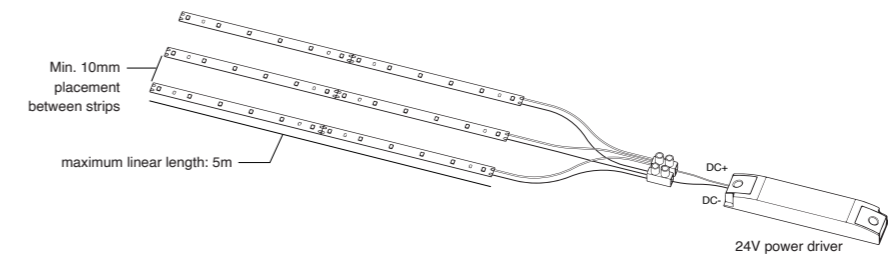

## Accessories

LED Strip Plastic Profile only compatible with IP65 version with silicone jacket

### WE MP1001-PM

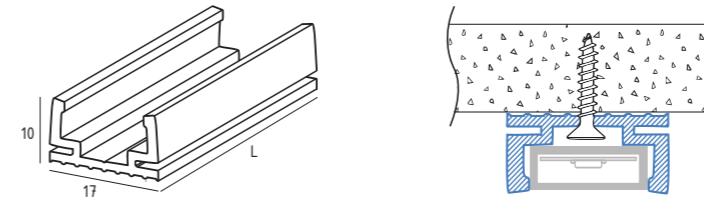

## Photometric Diagram

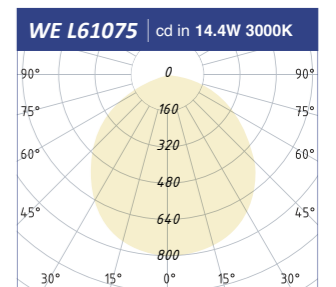

## Compatible LED Driver

| Order Code                      | Effective Power | Output                | Wiring Box Dimensions<br>L x W x H (mm) | Required Cut Hole<br>(mm) |
|---------------------------------|-----------------|-----------------------|---|---------------------------|
| <b>TD OS-24V-60N-ELV1(12A)</b>  | Max. 48W        | 24V                   | 360 x 90 x 40                           | ø98                       |
| <b>TD OS-24V-120N-ELV2(12A)</b> | Max. 96W        | 24V                   | 360 x 90 x 40                           | ø98                       |
| <b>TD LT-24V-75A-LMV2(12A)</b>  | Max. 60W        | 24V<br>0-10V dimmable | 360 x 90 x 40                           | ø98                       |
| <b>TD LT-24V-150A-LMV3(13A)</b> | Max. 120W       | 24V<br>0-10V dimmable | 360 x 90 x 40                           | ø98                       |

# RGBW Strip

- Multiple color options by color mixing
- 3M self-adhesive double-sided tape attached
- Water-proof silicone jacket for IP65 version
- Customized length available on request
- Remote driver, separate order



IP20

**WE L61085 - 90**

| CRI | CCT   | Power | Length |
|-----|-------|-------|--------|
| 27  | 2700K | 19.2  | 19.2W  |
| 30  | 3000K |       |        |
| 40  | 4000K |       |        |

SMD 24V DC Ra90+ 60pcs LED/m 19.2W/m

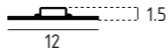

IP65 with silicone jacket

**WE L61086 - 90**

| CRI | CCT   | Power | Length |
|-----|-------|-------|--------|
| 27  | 2700K | 19.2  | 19.2W  |
| 30  | 3000K |       |        |
| 40  | 4000K |       |        |

SMD 24V DC Ra90+ 60pcs LED/m 19.2W/m

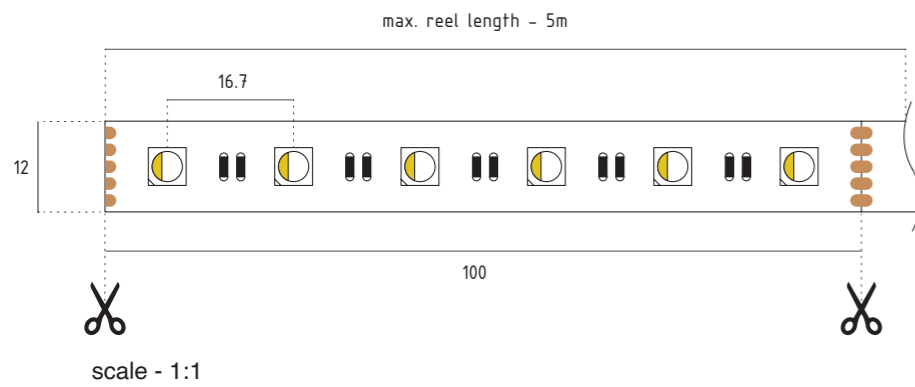
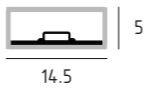

## Connection Guideline

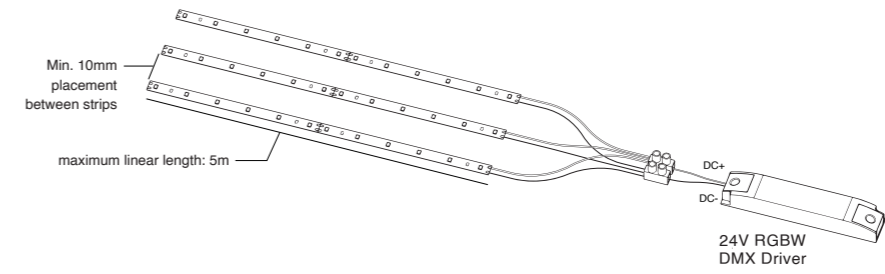

## Compatible LED Driver

| Order Code                     | Effective Power | Output              | Wiring Box Dimensions<br>L x W x H (mm) | Required Cut Hole<br>(mm) |
|--------------------------------|-----------------|---------------------|---|---------------------------|
| <b>TD LT24V-150A-G4K3(13A)</b> | Max. 120W       | 24V RGBW DMX Driver | 320 x 90 x 40                           | ø98                       |

# Tunable White Strip

- Tunable white LED strip, colour temperature ranging from 2700K – 6500K
- 3M self-adhesive double-sided tape attached
- Water-proof silicone jacket for IP65 version
- Customized length available on request
- Remote driver, separate order



IP20  
**WE L61079 - 902765 -**   **Length in mm**

| Power | Length |
|-------|--------|
| 4.8   | 4.8W   |
| 9.6   | 9.6W   |
| 14.4  | 14.4W  |

SMD 24V DC Ra90+ 70+70pcs LED/m 14.4W/m 1204lm/m (2700-6500K)

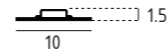

IP65 with silicone jacket  
**WE L61080 - 902765 -**   **Length in mm**

| Power | Length |
|-------|--------|
| 4.8   | 4.8W   |
| 9.6   | 9.6W   |
| 14.4  | 14.4W  |

SMD 24V DC Ra90+ 70+70pcs LED/m 14.4W/m 1204lm/m (2700-6500K)

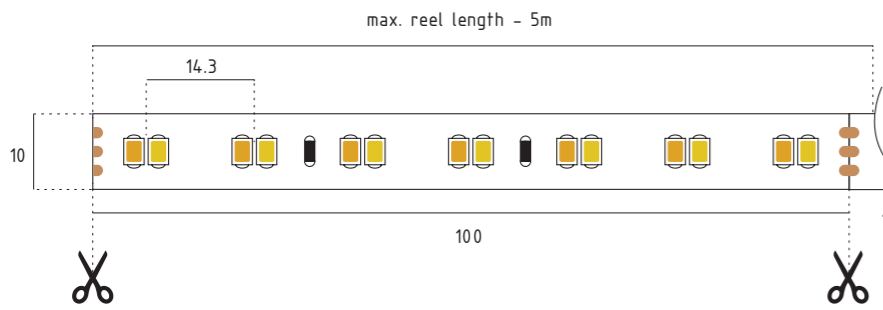
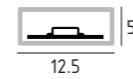

scale - 1:1

## Connection Guideline

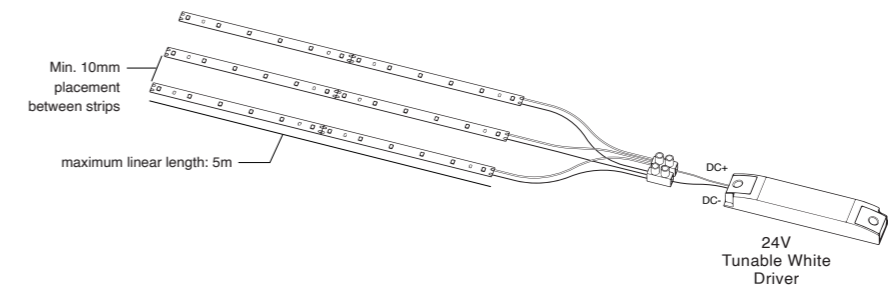

## Accessories

LED Strip Plastic Profile only compatible with IP65 version with silicone jacket

### WE MP1001-PM

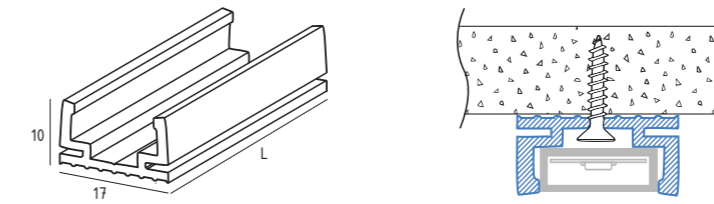

## Photometric Diagram

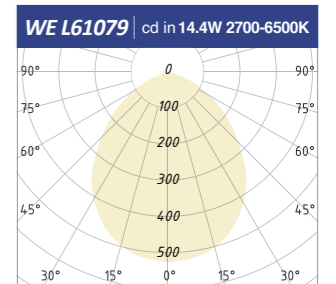

## Compatible LED Driver

| Order Code                     | Effective Power | Output                   | Wiring Box Dimensions<br>L x W x H (mm) | Required Cut Hole<br>(mm) |
|--------------------------------|-----------------|--------------------------|---|---------------------------|
| <b>TD LT24V-75A-G2A2(12A)</b>  | Max. 60W        | 24V TW<br>0-10V dimmable | 320 x 90 x 40                           | ø98                       |
| <b>TD LT24V-150A-G2A2(13A)</b> | Max. 120W       | 24V TW<br>0-10V dimmable | 360 x 90 x 40                           | ø98                       |
| <b>TD LT24V-75A-G2D2(12A)</b>  | Max. 60W        | 24V TW<br>DALI dimmable  | 320 x 90 x 40                           | ø98                       |
| <b>TD LT24V-150A-G2D2(13A)</b> | Max. 120W       | 24V TW<br>DALI dimmable  | 360 x 90 x 40                           | ø98                       |



02

# Flexi-Glow

Extruded Silicone Strip

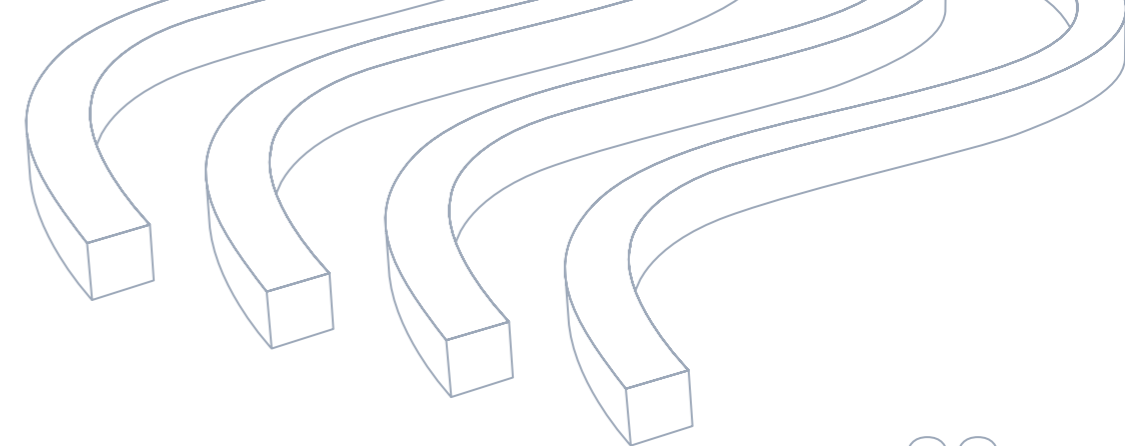

**Flexi-Glow S4**

22

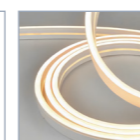

**Flexi-Glow S6**

24

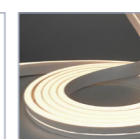

**Flexi-Glow S12**

26

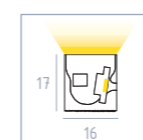

**Flexi-Glow S16**

28

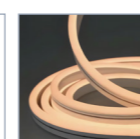

**Flexi-Glow T10**

30

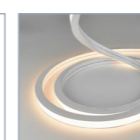
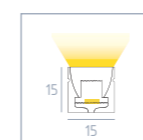

**Flexi-Glow T15**

32



**Flexi-Glow T20**

34

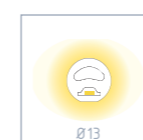

**Flexi-Glow F13**

36

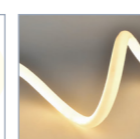
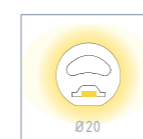

**Flexi-Glow F20**

38



# Flexi-Glow S4 IP67

- Extruded silicone strip
- Corrosion-resistant
- Continuous light-emitting surface, light-dot-free
- Customizable length
- Standard in IP67, IP68 version available on request

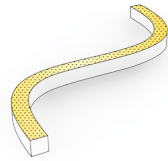
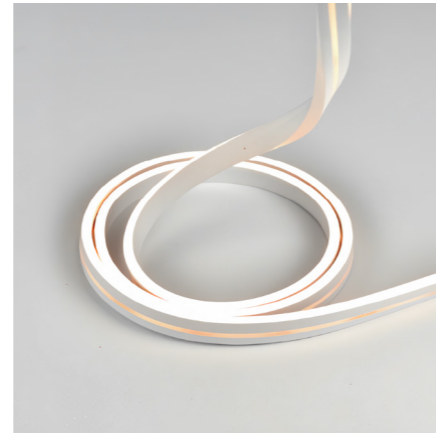

Side-bending

## WE U61020 -

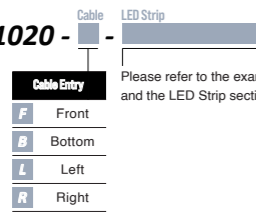

Please refer to the example on the right page for ordering guideline, and the LED Strip section for the full code of various options of the strips.

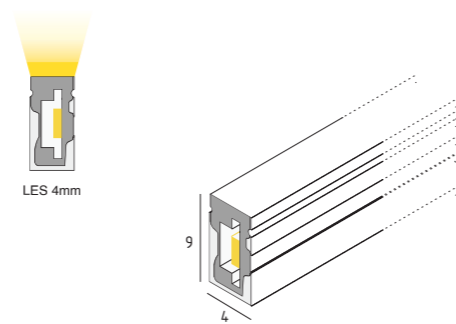

## Cable

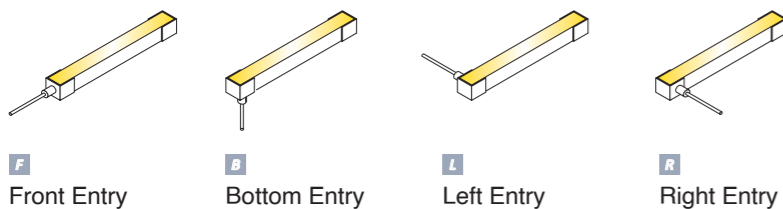

## Mounting Accessories

### WE MP1004-PM

Aluminum Channel

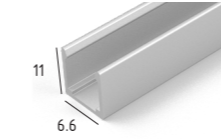

### WE MP1004-50

Aluminum Clip

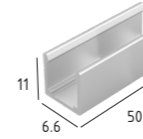

### WE MP1005-PM

Flexible Aluminum Clip

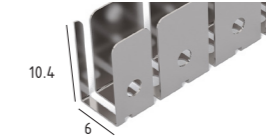

## Compatible LED Strip Options

|                                      | Slim Strip      |      |      |
|--------------------------------------|-----------------|------|------|
| 5mm printed circuit board compatible |                 |      |      |
| Max. Linear Length                   | 5m              |      |      |
| Power/m (W)                          | 4.8             |      | 9.6  |
| No. of LEDs/m                        | 120             |      |      |
| CCT (k)                              | 2700            | 3000 | 4000 |
| CRI (Ra)                             | 90+             |      |      |
| Ordering Code*                       | WE L61083-..... |      |      |

## Ordering Guideline

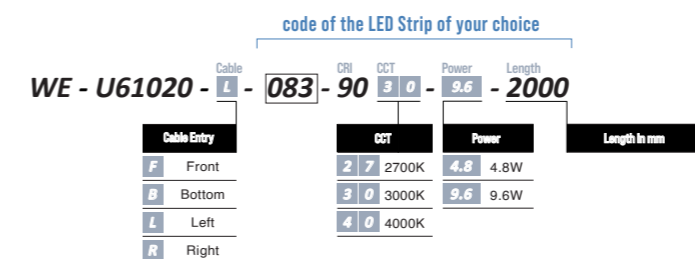

Flexi-Glow S4 with Left Cable Entry, completed with Slim Strip, Ra90+, 3000K, 9.6W, 2 meters in length

# Flexi-Glow S6 IP67

- Extruded siliconestrip
- Corrosion-resistant
- Continuous light-emitting surface, light-dot-free
- Customizable length
- Standard in IP67, IP68 version available on request

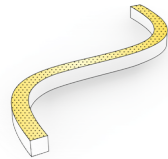

Side-bending

## WE U61021 -

- Cable Entry**
- F** Front
  - B** Bottom
  - L** Left
  - R** Right

Please refer to the example on the right page for ordering guideline, and the LED Strip section for the full code of various options of the strips.

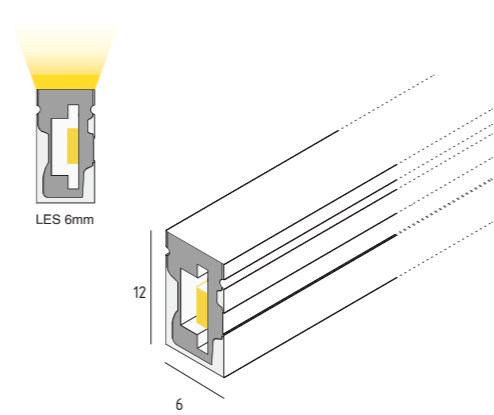

## Cable

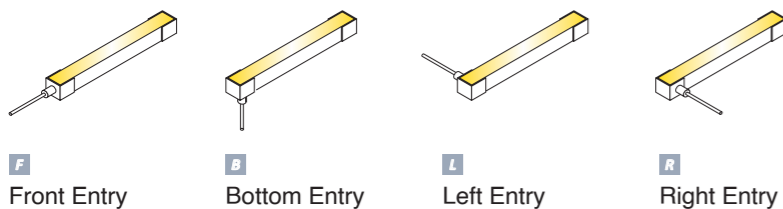

## Mounting Accessories

### WE MP1006-PM

Aluminum Channel

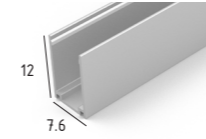

### WE MP1006-50

Aluminum Clip

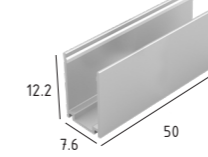

### WE MP1007-PM

Flexible Aluminum Clip

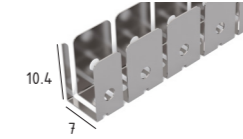

## Compatible LED Strip Options

| 8mm printed circuit board compatible | HE Strip           |      |      | ECO Strip       |      |      | Tunable White Strip |      |      |      |                          |
|--------------------------------------|--------------------|------|------|-----------------|------|------|---------------------|------|------|------|--------------------------|
|                                      | Max. Linear Length | 5m   |      |                 |      |      |                     |      |      |      |                          |
| Power/m (W)                          | 4.8                | 9.6  | 14.4 | 4.8             | 9.6  | 14.4 | 4.8                 | 9.6  | 14.4 |      |                          |
| No. of LEDs/m                        | 160                |      |      | 120             |      |      | 60+60               |      |      |      |                          |
| CCT (k)                              | 2400               | 2700 | 3000 | 3500            | 4000 | 2400 | 2700                | 3000 | 3500 | 4000 | 2700-6500k tunable white |
| CRI (Ra)                             | 90+                |      |      | 90+             |      |      | 90+                 |      |      |      |                          |
| Ordering Code*                       | WE L61102-.....    |      |      | WE L61104-..... |      |      | WE L61099-.....     |      |      |      |                          |

\*Please refer to the LED Strip section for the full ordering code

## Ordering Guideline

code of the LED Strip of your choice

WE U61021 - **L** - **102** - **90** - **30** - **9.6** - **2000**

| Cable Entry     | CCT             | Power             | Length in mm |
|-----------------|-----------------|-------------------|--------------|
| <b>F</b> Front  | <b>24</b> 2400K | <b>4.8</b> 4.8W   |              |
| <b>B</b> Bottom | <b>27</b> 2700K | <b>9.6</b> 9.6W   |              |
| <b>L</b> Left   | <b>30</b> 3000K | <b>14.4</b> 14.4W |              |
| <b>R</b> Right  | <b>35</b> 3500K |                   |              |
|                 | <b>40</b> 4000K |                   |              |

Flexi-Glow S6 with Left Cable Entry, completed with HE Strip, Ra90+, 3000K, 9.6W, 2 meters in length

# Flexi-Glow S12 IP67

- Extruded siliconestrip
- Corrosion-resistant
- Continuous light-emitting surface, light-dot-free
- Customizable length
- Standard in IP67, IP68 version available on request

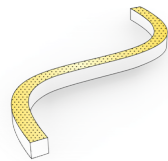

Side-bending

**WE U61022** - Cable LED Strip

Please refer to the example on the right page for ordering guideline, and the LED Strip section for the full code of various options of the strips.

| Cable Entry |        |
|-------------|--------|
| <b>F</b>    | Front  |
| <b>B</b>    | Bottom |
| <b>L</b>    | Left   |
| <b>R</b>    | Right  |

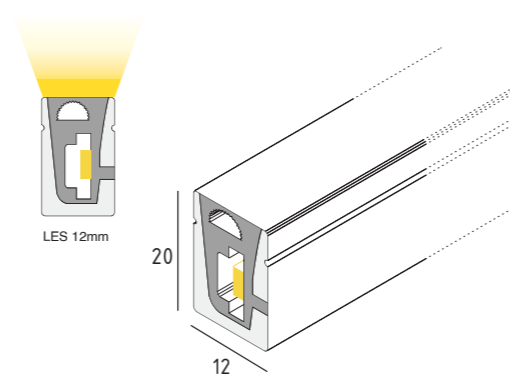

## Mounting Accessories

### WE MP1008-PM

Aluminum Channel

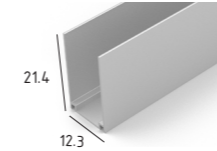

### WE MP1008-50

Aluminum Clip

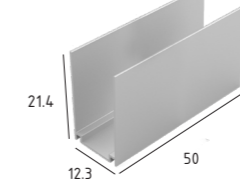

### WE MP1009-PM

Flexible Aluminum Clip

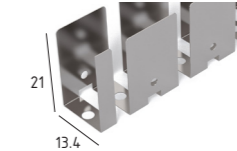

## Compatible LED Strip Options

| 10mm printed circuit board compatible | Extra Long Strip    |             |              | HE Strip                 |     |      | ECO Strip           |     |      | Tunable White Strip      |     |      |
|---------------------------------------|---------------------|-------------|--------------|--------------------------|-----|------|---------------------|-----|------|--------------------------|-----|------|
|                                       | 4.8W<br>25m         | 9.6W<br>15m | 14.4W<br>10m | 5m                       |     |      |                     |     |      |                          |     |      |
| Max. Linear Length                    | 4.8                 | 9.6         | 14.4         | 4.8                      | 9.6 | 14.4 | 4.8                 | 9.6 | 14.4 | 4.8                      | 9.6 | 14.4 |
| Power/m (W)                           | 120                 |             |              | 160                      |     |      | 120                 |     |      | 70+70                    |     |      |
| No. of LEDs/m                         | 2700 3000 3500 4000 |             |              | 2400 2700 3000 3500 4000 |     |      | 2700 3000 3500 4000 |     |      | 2700-6500k tunable white |     |      |
| CCT (k)                               | 90+                 |             |              | 90+                      |     |      | 90+                 |     |      | 90+                      |     |      |
| CRI (Ra)                              | WE L61093-.....     |             |              | WE L61075-.....          |     |      | WE L61010-.....     |     |      | WE L61079-.....          |     |      |
| Ordering Code*                        |                     |             |              |                          |     |      |                     |     |      |                          |     |      |

\*Please refer to the LED Strip section for the full ordering code

## Cable

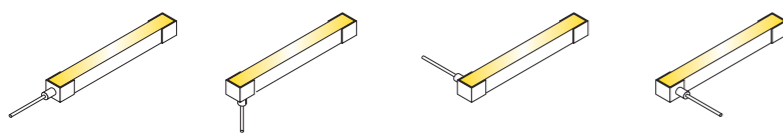

**F** Front Entry    **B** Bottom Entry    **L** Left Entry    **R** Right Entry

## Ordering Guideline

code of the LED Strip of your choice

**WE U61022** - Cable **L** - **093** - **9** **3** **0** - **14.4** - **2000**

| Cable Entry     | CCT              | Power             | Length in mm |
|-----------------|------------------|-------------------|--------------|
| <b>F</b> Front  | <b>2</b> 7 2700K | <b>4.8</b> 4.8W   |              |
| <b>B</b> Bottom | <b>3</b> 0 3000K | <b>9.6</b> 9.6W   |              |
| <b>L</b> Left   | <b>3</b> 5 4000K | <b>14.4</b> 14.4W |              |
| <b>R</b> Right  | <b>4</b> 0 4000K |                   |              |

Flexi-Glow S12 with Left Cable Entry, completed with *Extra Long Strip, Ra90+, 3000K, 14.4W, 2 meters in length*

# Flexi-Glow S16 IP67

- Extruded siliconestrip
- Corrosion-resistant
- Continuous light-emitting surface, light-dot-free
- Customizable length
- Standard in IP67, IP68 version available on request

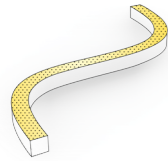
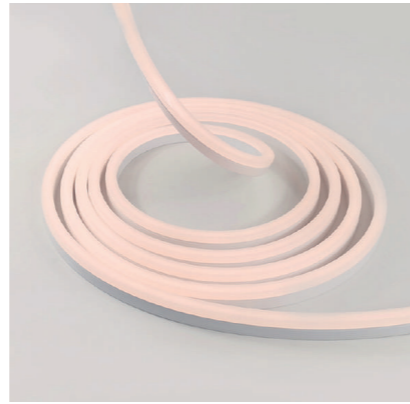

Side-bending

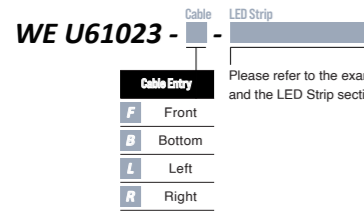

Please refer to the example on the right page for ordering guideline, and the LED Strip section for the full code of various options of the strips.

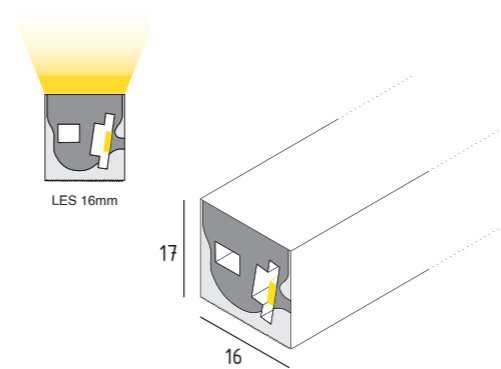

## Mounting Accessories

### WE MP1010-PM

Aluminum Channel

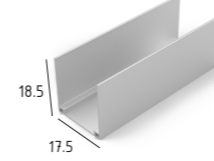

### WE MP1010-25

Aluminum Clip

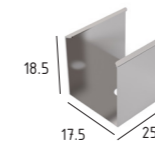

### WE MP1011-PM

Flexible Aluminum Clip

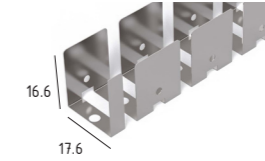

## Compatible LED Strip Options

| 10mm printed circuit board compatible | Extra Long Strip    |             |              | HE Strip                 |     |      | ECO Strip                |     |      | Tunable White Strip      |     |      |
|---------------------------------------|---------------------|-------------|--------------|--------------------------|-----|------|--------------------------|-----|------|--------------------------|-----|------|
|                                       | 4.8W<br>25m         | 9.6W<br>15m | 14.4W<br>10m | 5m                       |     |      |                          |     |      |                          |     |      |
| Max. Linear Length                    | 4.8                 | 9.6         | 14.4         | 4.8                      | 9.6 | 14.4 | 4.8                      | 9.6 | 14.4 | 4.8                      | 9.6 | 14.4 |
| Power/m (W)                           | 120                 |             |              | 160                      |     |      | 120                      |     |      | 70+70                    |     |      |
| No. of LEDs/m                         | 2700 3000 3500 4000 |             |              | 2400 2700 3000 3500 4000 |     |      | 2400 2700 3000 3500 4000 |     |      | 2700-6500k tunable white |     |      |
| CCT (k)                               | 90+                 |             |              | 90+                      |     |      | 90+                      |     |      | 90+                      |     |      |
| CRI (Ra)                              | WE L61093-.....     |             |              | WE L61075-.....          |     |      | WE L61010-.....          |     |      | WE L61079-.....          |     |      |
| Ordering Code*                        |                     |             |              |                          |     |      |                          |     |      |                          |     |      |

\*Please refer to the LED Strip section for the full ordering code

## Cable

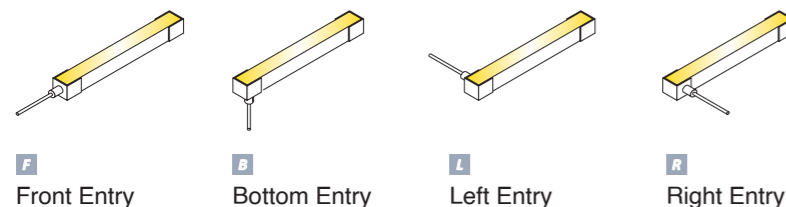

## Ordering Guideline

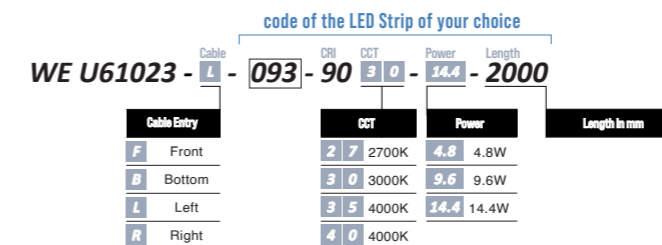

Flexi-Glow S16 with Left Cable Entry, completed with *Extra Long Strip, Ra90+, 3000K, 14.4W, 2 meters in length*

# Flexi-Glow T10 IP67

- Extruded siliconestrip
- Corrosion-resistant
- Continuous light-emitting surface, light-dot-free
- Customizable length
- Standard in IP67, IP68 version available on request
- Wide angle, 3-way light-emitting surface

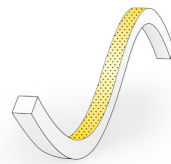

Top-bending

## WE U61030 -

| Cable Entry |        |
|-------------|--------|
| <b>F</b>    | Front  |
| <b>B</b>    | Bottom |
| <b>L</b>    | Left   |
| <b>R</b>    | Right  |

Please refer to the example on the right page for ordering guideline, and the LED Strip section for the full code of various options of the strips.

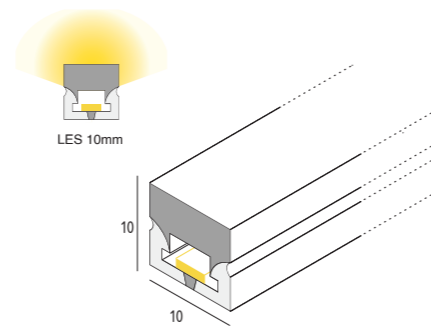

## Cable

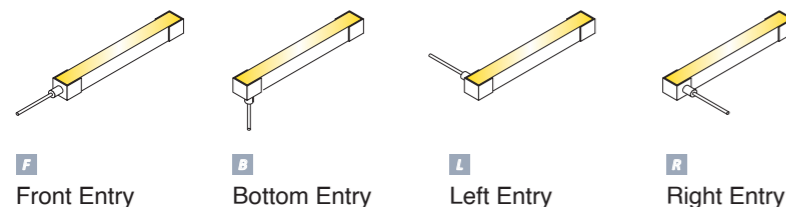

**F** Front Entry    **B** Bottom Entry    **L** Left Entry    **R** Right Entry

## Mounting Accessories

**WE MP1012-PM**  
Aluminum Channel

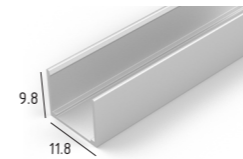

**WE MP1012-50**  
Aluminum Clip

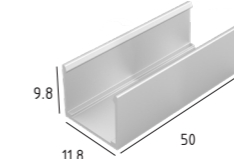

**WE MP1013-PM**  
Flexible Aluminum Clip

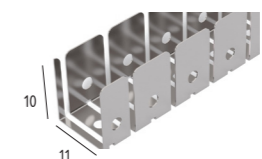

## Compatible LED Strip Options

|                                      | ECO Pro Strip         |      |      |
|--------------------------------------|-----------------------|------|------|
| 7mm printed circuit board compatible |                       |      |      |
| Max. Linear Length                   | 5m                    |      |      |
| Power/m (W)                          | 4.8                   | 9.6  |      |
| No. of LEDs/m                        | 168                   |      |      |
| CCT (k)                              | 2700                  | 3000 | 4000 |
| CRI (Ra)                             | 90+                   |      |      |
| Ordering Code*                       | <b>WE L61108</b> -... |      |      |

\*Please refer to the LED Strip section for the full ordering code

## Ordering Guideline

code of the LED Strip of your choice

**WE U61030 - L - 108 - 90 - 30 - 9.6 - 2000**

| Cable Entry     | CCT             | Power           | Length in mm |
|-----------------|-----------------|-----------------|--------------|
| <b>F</b> Front  | <b>27</b> 2700K | <b>4.8</b> 4.8W |              |
| <b>B</b> Bottom | <b>30</b> 3000K | <b>9.6</b> 9.6W |              |
| <b>L</b> Left   | <b>40</b> 4000K |                 |              |
| <b>R</b> Right  |                 |                 |              |

Flexi-Glow T10 with Left Cable Entry, completed with *Eco Pro Strip*, Ra90+, 3000K, 9.6W, 2 meters in length

# Flexi-Glow T15 IP67

- Extruded siliconestrip
- Corrosion-resistant
- Continuous light-emitting surface, light-dot-free
- Customizable length
- Standard in IP67, IP68 version available on request

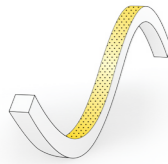

Top-bending

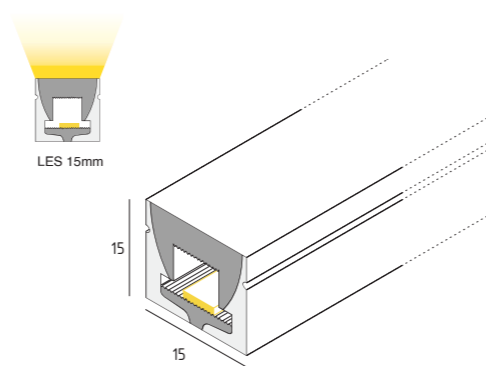
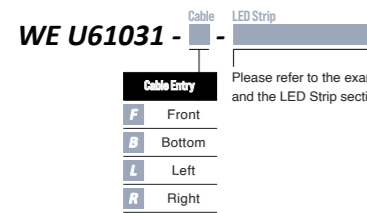
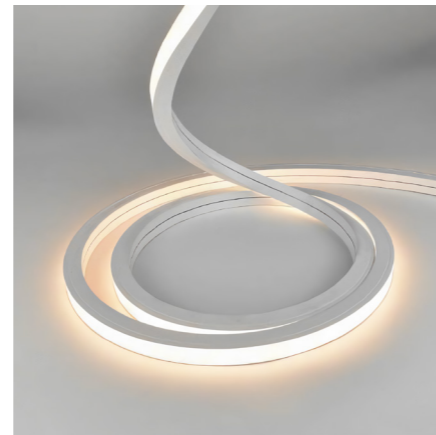

## Cable

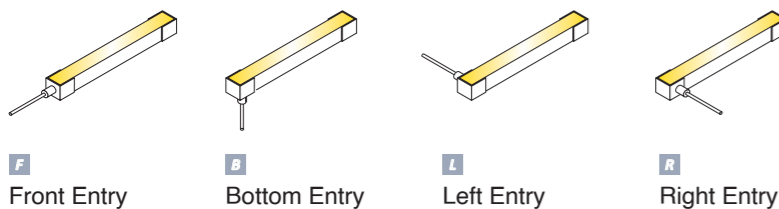

**F** Front Entry    **B** Bottom Entry    **L** Left Entry    **R** Right Entry

## Mounting Accessories

**WE MP1014-PM**  
Aluminum Channel

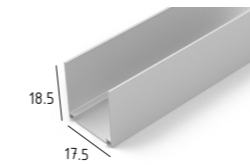

**WE MP1014-25**  
Aluminum Clip

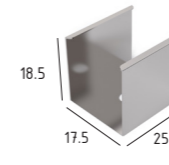

**WE MP1015-PM**  
Flexible Aluminum Clip

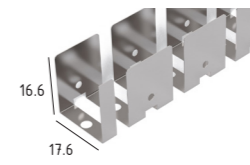

## Compatible LED Strip Options

| 10mm printed circuit board compatible | Extra Long Strip        |             |              | HE Strip                |      |      | ECO Strip               |      |      | Tunable White Strip     |      |      |      |      |                          |
|---------------------------------------|-------------------------|-------------|--------------|-------------------------|------|------|-------------------------|------|------|-------------------------|------|------|------|------|--------------------------|
|                                       | 4.8W<br>25m             | 9.6W<br>15m | 14.4W<br>10m | 5m                      |      |      |                         |      |      |                         |      |      |      |      |                          |
| Power/m (W)                           | 4.8                     | 9.6         | 14.4         | 4.8                     | 9.6  | 14.4 | 4.8                     | 9.6  | 14.4 | 4.8                     | 9.6  | 14.4 |      |      |                          |
| No. of LEDs/m                         | 120                     |             |              | 160                     |      |      | 120                     |      |      | 70+70                   |      |      |      |      |                          |
| CCT (k)                               | 2700                    | 3000        | 3500         | 4000                    | 2400 | 2700 | 3000                    | 3500 | 4000 | 2400                    | 2700 | 3000 | 3500 | 4000 | 2700-6500k tunable white |
| CRI (Ra)                              | 90+                     |             |              | 90+                     |      |      | 90+                     |      |      | 90+                     |      |      |      |      |                          |
| Ordering Code*                        | <b>WE L61093</b> -..... |             |              | <b>WE L61075</b> -..... |      |      | <b>WE L61010</b> -..... |      |      | <b>WE L61079</b> -..... |      |      |      |      |                          |

\*Please refer to the LED Strip section for the full ordering code

## Ordering Guideline

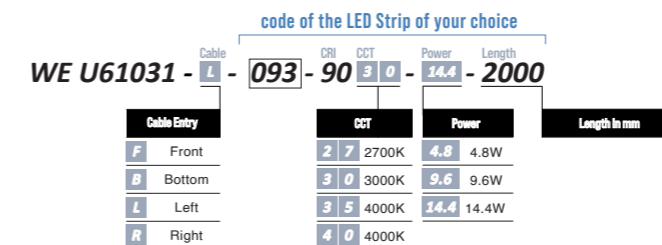

Flexi-Glow T15 with Left Cable Entry, completed with **Extra Long Strip, Ra90+, 3000K, 14.4W, 2 meters in length**



# Flexi-Glow T20 IP67

- Extruded siliconestrip
- Corrosion-resistant
- Continuous light-emitting surface, light-dot-free
- Customizable length
- Standard in IP67, IP68 version available on request
- Wide angle, 3-way light-emitting surface

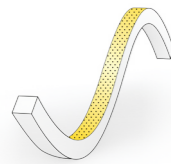

Top-bending

## WE U61032 -

| Cable Entry |        |
|-------------|--------|
| <b>F</b>    | Front  |
| <b>B</b>    | Bottom |
| <b>L</b>    | Left   |
| <b>R</b>    | Right  |

Please refer to the example on the right page for ordering guideline, and the LED Strip section for the full code of various options of the strips.

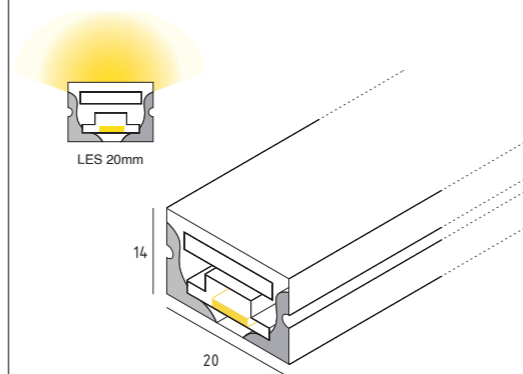

## Cable

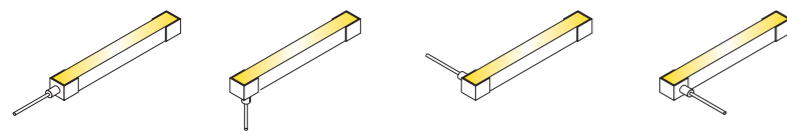

**F** Front Entry    **B** Bottom Entry    **L** Left Entry    **R** Right Entry

## Mounting Accessories

### WE MP1016-PM

Aluminum Channel

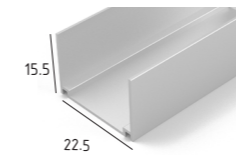

### WE MP1016-50

Aluminum Clip

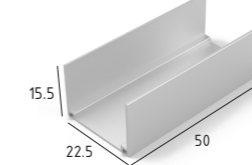

### WE MP1017-PM

Flexible Aluminum Clip

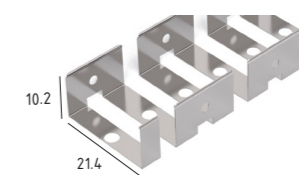

## Compatible LED Strip Options

| 10mm printed circuit board compatible | Extra Long Strip |             |              | HE Strip        |      |      | ECO Strip       |      |      | Tunable White Strip |      |      |      |      |                          |
|---------------------------------------|------------------|-------------|--------------|-----------------|------|------|-----------------|------|------|---------------------|------|------|------|------|--------------------------|
|                                       | 4.8W<br>25m      | 9.6W<br>15m | 14.4W<br>10m | 5m              |      |      | 5m              |      |      | 5m                  |      |      |      |      |                          |
| Max. Linear Length                    | 4.8W<br>25m      | 9.6W<br>15m | 14.4W<br>10m | 5m              |      |      | 5m              |      |      | 5m                  |      |      |      |      |                          |
| Power/m (W)                           | 4.8              | 9.6         | 14.4         | 4.8             | 9.6  | 14.4 | 4.8             | 9.6  | 14.4 | 4.8                 | 9.6  | 14.4 |      |      |                          |
| No. of LEDs/m                         | 120              |             |              | 160             |      |      | 120             |      |      | 70+70               |      |      |      |      |                          |
| CCT (k)                               | 2700             | 3000        | 3500         | 4000            | 2400 | 2700 | 3000            | 3500 | 4000 | 2400                | 2700 | 3000 | 3500 | 4000 | 2700-6500k tunable white |
| CRI (Ra)                              | 90+              |             |              | 90+             |      |      | 90+             |      |      | 90+                 |      |      |      |      |                          |
| Ordering Code*                        | WE L61093-.....  |             |              | WE L61075-..... |      |      | WE L61010-..... |      |      | WE L61079-.....     |      |      |      |      |                          |

\*Please refer to the LED Strip section for the full ordering code

## Ordering Guideline

code of the LED Strip of your choice

WE U61032 - **L** - **093** - **90** **3** **0** - **14.4** - **2000**

| Cable Entry     | CCT              | Power             | Length in mm |
|-----------------|------------------|-------------------|--------------|
| <b>F</b> Front  | <b>2 7</b> 2700K | <b>4.8</b> 4.8W   |              |
| <b>B</b> Bottom | <b>3 0</b> 3000K | <b>9.6</b> 9.6W   |              |
| <b>L</b> Left   | <b>3 5</b> 4000K | <b>14.4</b> 14.4W |              |
| <b>R</b> Right  | <b>4 0</b> 4000K |                   |              |

Flexi-Glow T20 with Left Cable Entry, completed with *Extra Long Strip, Ra90+, 3000K, 14.4W, 2 meters in length*



# Flexi-Glow F13 IP67

- Extruded siliconestrip
- Corrosion-resistant
- Continuous light-emitting surface, light-dot-free
- Customizable length
- Standard in IP67, IP68 version available on request
- Free bending

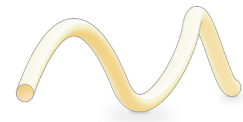

3D Free Bending

## WE U61040 - F -



Please refer to the example on the right page for *ordering guideline*, and the LED Strip section for the *full code* of various options of the strips.

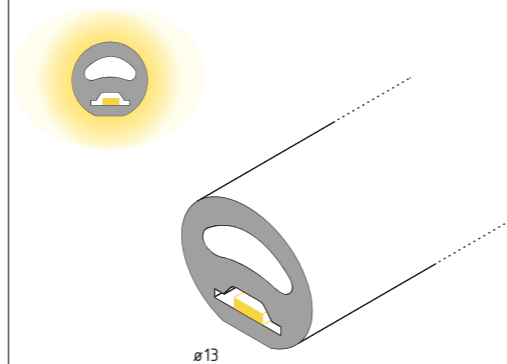

## Cable

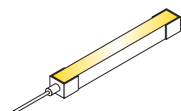

F Front Entry

## Mounting Accessory

### WE MP1018

Mounting Clip

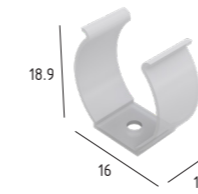

## Compatible LED Strip Options

|                                      | Slim Strip  |      |      |
|--------------------------------------|---|------|------|
| 5mm printed circuit board compatible |  |      |      |
| Max. Linear Length                   | 5m  |      |      |
| Power/m (W)                          | 4.8   | 9.6  | 14.4 |
| No. of LEDs/m                        | 120   |      |      |
| CCT (k)                              | 2700  | 3000 | 4000 |
| CRI (Ra)                             | 90+   |      |      |
| Ordering Code*                       | WE L61083-.....   |      |      |

## Ordering Guideline

code of the LED Strip of your choice

Cable Entry: WE U61040 - F - 083 - CRI: 90 - CCT: 30 - Power: 14.4 - Length: 2000

| CCT  | Power  | Length in mm |
|--|--|--------------|
| <span style="border: 1px solid black; padding: 2px;">27</span> 2700K | <span style="border: 1px solid black; padding: 2px;">4.8</span> 4.8W   |              |
| <span style="border: 1px solid black; padding: 2px;">30</span> 3000K | <span style="border: 1px solid black; padding: 2px;">9.6</span> 9.6W   |              |
| <span style="border: 1px solid black; padding: 2px;">40</span> 4000K | <span style="border: 1px solid black; padding: 2px;">14.4</span> 14.4W |              |

Flexi-Glow F13 with Front Cable Entry, completed with *Slim Strip, Ra90+, 3000K, 14.4W, 2 meters in length*

# Flexi-Glow F20 IP67

- Extruded siliconestrip
- Corrosion-resistant
- Continuous light-emitting surface, light-dot-free
- Customizable length
- Standard in IP67, IP68 version available on request
- Free bending

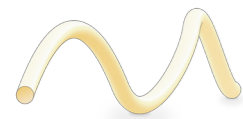

3D Free Bending

## WE U61041 - F -



Please refer to the example on the right page for ordering guideline, and the LED Strip section for the full code of various options of the strips.

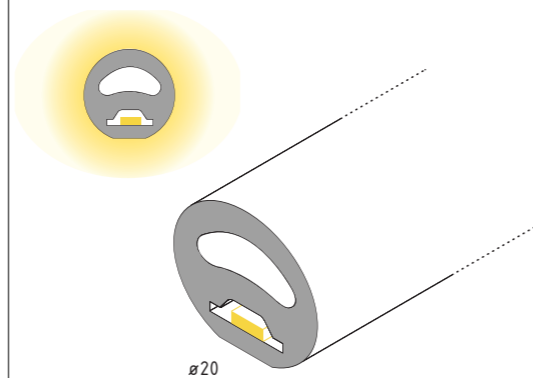

## Cable

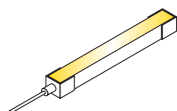

F Front Entry

## Mounting Accessory

### WE MP1019

Mounting Clip

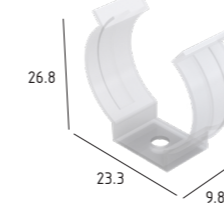

## Compatible LED Strip Options

| 10mm printed circuit board compatible | Extra Long Strip    |             |              | HE Strip                 |     |      | ECO Strip                |     |      | Tunable White Strip      |     |      |
|---------------------------------------|---------------------|-------------|--------------|--------------------------|-----|------|--------------------------|-----|------|--------------------------|-----|------|
|                                       | 4.8W<br>25m         | 9.6W<br>15m | 14.4W<br>10m | 5m                       |     |      |                          |     |      |                          |     |      |
| Max. Linear Length                    | 4.8                 | 9.6         | 14.4         | 4.8                      | 9.6 | 14.4 | 4.8                      | 9.6 | 14.4 | 4.8                      | 9.6 | 14.4 |
| Power/m (W)                           | 120                 |             |              | 160                      |     |      | 120                      |     |      | 70+70                    |     |      |
| No. of LEDs/m                         | 2700 3000 3500 4000 |             |              | 2400 2700 3000 3500 4000 |     |      | 2400 2700 3000 3500 4000 |     |      | 2700-6500k tunable white |     |      |
| CCT (k)                               | 90+                 |             |              | 90+                      |     |      | 90+                      |     |      | 90+                      |     |      |
| CRI (Ra)                              | WE L61093-.....     |             |              | WE L61075-.....          |     |      | WE L61010-.....          |     |      | WE L61079-.....          |     |      |
| Ordering Code*                        |                     |             |              |                          |     |      |                          |     |      |                          |     |      |

\*Please refer to the LED Strip section for the full ordering code

## Ordering Guideline

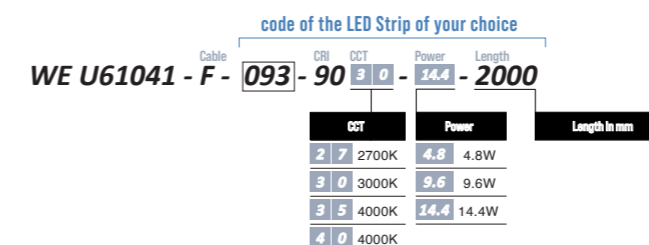

Flexi-Glow F20 with Front Cable Entry, completed with **Extra Long Strip, Ra90+, 3000K, 14.4W, 2 meters in length**

03

# Ray-Glow

Extruded Aluminum Channel

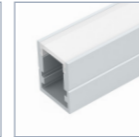
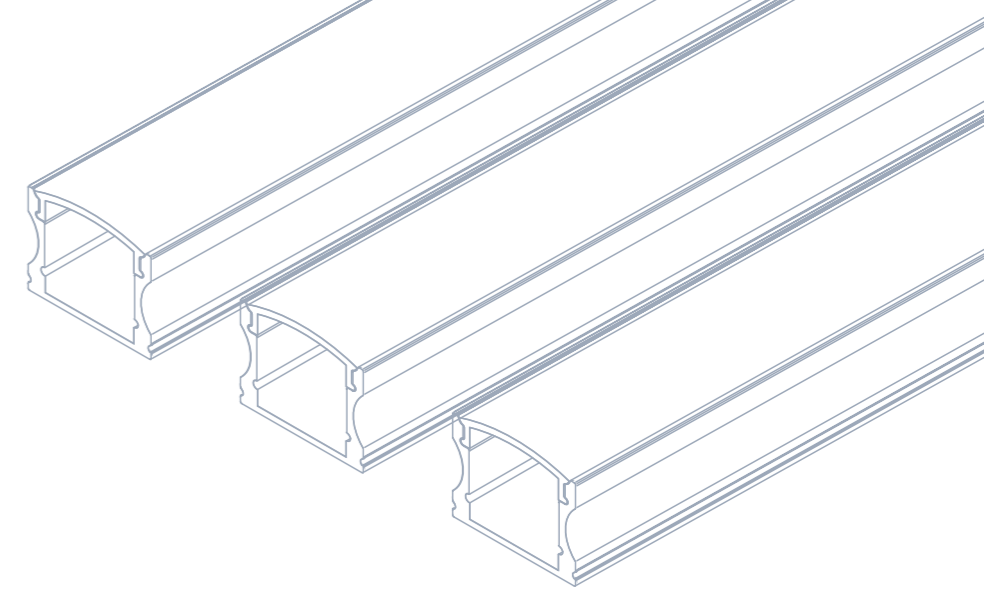

**Ray-Glow Comfort**

42

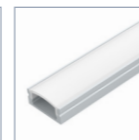

**Ray-Glow Extra Flat**

42



**Ray-Glow Corner S**

44

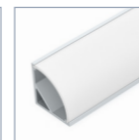

**Ray-Glow Corner L**

44

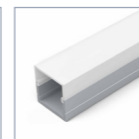
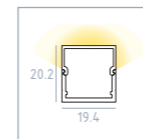

**Ray-Glow 3-Direction**

46

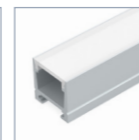

**Ray-Glow Magnet**

48

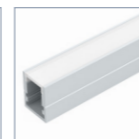

**Ray-Glow Thin**

50

# Ray-Glow Comfort/ Extra Flat

- Extruded Aluminum Channel with PC diffuser for LED strip
- 2 different heights suitable for various applications
- 12mm PCB LED strip compatible
- Customizable length

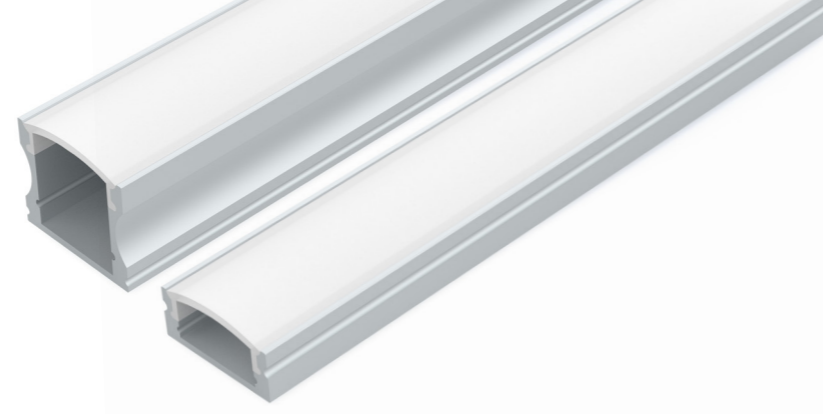

## Mounting Accessory

### WE MP1020

Plastic Clip

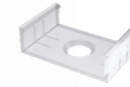

### WE MP1021

Adjustable Metal Clip

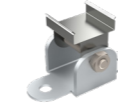

## Ray-Glow Comfort

Aluminum Channel w/ LED Strip

**WE U51023 -**



- Cable Entry**
- F Front
  - B Bottom
  - L Left
  - R Right

Please refer to the example on the right page for ordering guideline, and the LED Strip section for the full code of various options of the strips.

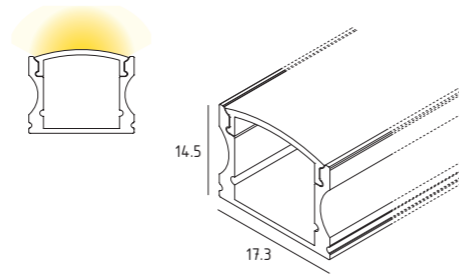

Aluminum Channel Only

**WE U51023 - F - PM**

## Ray-Glow Extra Flat

Aluminum Channel w/ LED Strip

**WE U51022 -**



- Cable Entry**
- F Front
  - B Bottom

Please refer to the example on the right page for ordering guideline, and the LED Strip section for the full code of various options of the strips.

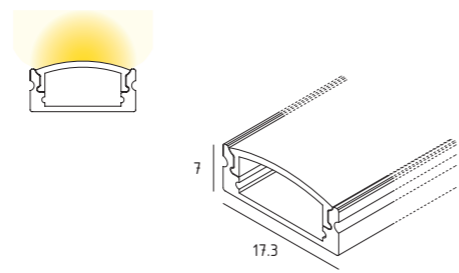

Aluminum Channel Only

**WE U51022 - F - PM**

## Cable

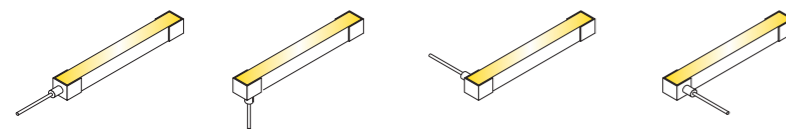

- F Front Entry
- B Bottom Entry
- L Left Entry
- R Right Entry

## Compatible LED Strip Options

| 10mm printed circuit board compatible | Extra Long Strip |             |              | HE Strip        |      |      | ECO Strip       |      |      | Tunable White Strip |      |      |      |      |                          |
|---------------------------------------|------------------|-------------|--------------|-----------------|------|------|-----------------|------|------|---------------------|------|------|------|------|--------------------------|
|                                       | 4.8W<br>25m      | 9.6W<br>15m | 14.4W<br>10m | 5m              |      |      |                 |      |      |                     |      |      |      |      |                          |
| Power/m (W)                           | 4.8              | 9.6         | 14.4         | 4.8             | 9.6  | 14.4 | 4.8             | 9.6  | 14.4 | 4.8                 | 9.6  | 14.4 |      |      |                          |
| No. of LEDs/m                         | 120              |             |              | 160             |      |      | 120             |      |      | 70+70               |      |      |      |      |                          |
| CCT (k)                               | 2700             | 3000        | 3500         | 4000            | 2400 | 2700 | 3000            | 3500 | 4000 | 2400                | 2700 | 3000 | 3500 | 4000 | 2700-6500k tunable white |
| CRI (Ra)                              | 90+              |             |              | 90+             |      |      | 90+             |      |      | 90+                 |      |      |      |      |                          |
| Ordering Code*                        | WE L61093-.....  |             |              | WE L61075-..... |      |      | WE L61010-..... |      |      | WE L61079-.....     |      |      |      |      |                          |

\*Please refer to the LED Strip section for the full ordering code

## Ordering Guideline

code of the LED Strip of your choice

**WE U61023 -** **L** - **093** - **90** **3** **0** - **14.4** - **2000**

| Cable Entry | CRI | CCT | Power | Length in mm |
|-------------|-----|-----|-------|--------------|
| F Front     | 2   | 7   | 2700K | 4.8 4.8W     |
| B Bottom    | 3   | 0   | 3000K | 9.6 9.6W     |
| L Left      | 3   | 5   | 4000K | 14.4 14.4W   |
| R Right     | 4   | 0   | 4000K |              |

Ray-Glow Comfort with Left Cable Entry, completed with *Extra Long Strip, Ra90+, 3000K, 14.4W, 2 meters in length*

# Ray-Glow Corner S/L

- Extruded aluminium profile with PC diffuser for LED strip
- 45° light-emitting surface for corner installation
- 2 different sizes suitable for various applications
- 4mm (Corner S) / 10mm (Corner L) PCB LED strip compatible
- Customizable length

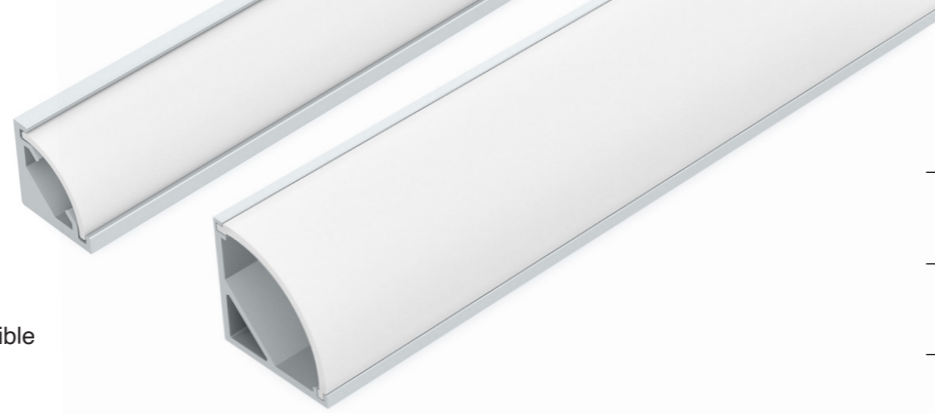

## Mounting Accessories

|              | Ray-Glow Corner S | Ray-Glow Corner L |
|--------------|-------------------|-------------------|
| Metal Clip   | <b>WE MP1022</b>  | NA                |
| Plastic Clip | NA                | <b>WE MP1023</b>  |

### Ray-Glow Corner S

Aluminum Channel w/ LED Strip

**WE U51024 - F -**



Please refer to the example on the right page for *ordering guideline*, and the LED Strip section for the *full code* of various options of the strips.

Aluminum Channel Only

**WE U51024 - F - PM**

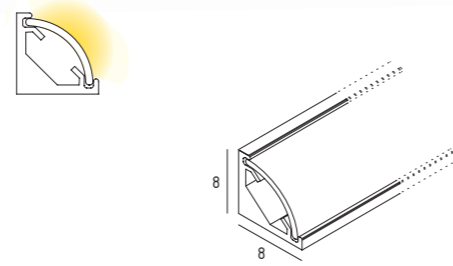

### Ray-Glow Corner L

Aluminum Channel w/ LED Strip

**WE U51025 -**



Please refer to the example on the right page for *ordering guideline*, and the LED Strip section for the *full code* of various options of the strips.

**Cable Entry**  
**F** Front  
**B** Bottom

Aluminum Channel Only

**WE U51025 - F - PM**

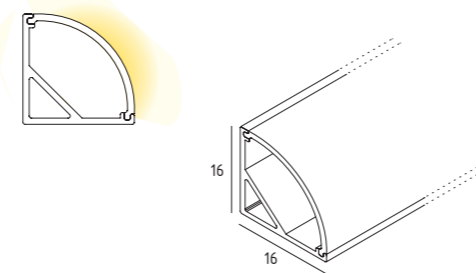

## Cable

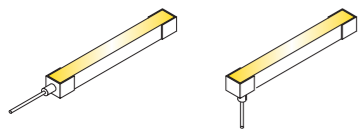

**F** Front Entry  
**B** Bottom Entry

## Compatible LED Strip Options

|                    | Ray-Glow Corner S<br>5mm printed circuit board compatible |      |                         |             |                         | Ray-Glow Corner L<br>10mm printed circuit board compatible |      |                         |      |      |      |      |
|--------------------|---|------|-------------------------|-------------|-------------------------|--|------|-------------------------|------|------|------|------|
|                    | Slim Strip  |      | Extra Long Strip        |             | HE Strip                | ECO Strip  |      | Tunable White Strip     |      |      |      |      |
| Max. Linear Length | 5m  |      | 4.8W<br>25m             | 9.6W<br>15m | 14.4W<br>10m            | 5m   |      |                         |      |      |      |      |
| Power/m (W)        | 4.8   | 9.6  | 4.8                     | 9.6         | 14.4                    | 4.8  | 9.6  | 14.4                    | 4.8  | 9.6  | 14.4 |      |
| No. of LEDs/m      | 120   |      | 120                     |             | 160                     | 120  |      | 60+60                   |      |      |      |      |
| CCT (k)            | 2700  | 3000 | 4000                    | 2700        | 3000                    | 3500   | 4000 | 2400                    | 2700 | 3000 | 3500 | 4000 |
| CRI (Ra)           | 90+   |      | 90+                     |             | 90+                     | 90+  |      | 90+                     |      |      |      |      |
| Ordering Code*     | <b>WE L61083</b> -.....                                   |      | <b>WE L61093</b> -..... |             | <b>WE L61075</b> -..... | <b>WE L61010</b> -.....                                    |      | <b>WE L61079</b> -..... |      |      |      |      |

\*Please refer to the LED Strip section for the full ordering code

## Ordering Guideline

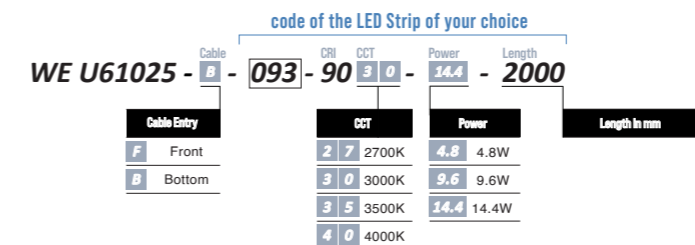

Ray-Glow Corner L with Bottom Cable Entry, completed with *Extra Long Strip, Ra90+, 3000K, 14.4W, 2 meters in length*



# Ray-Glow 3-direction

- Extruded aluminium profile with PC diffuser for LED strip
- 3-way light-emitting surface
- 12mm PCB LED strip compatible
- Customizable length

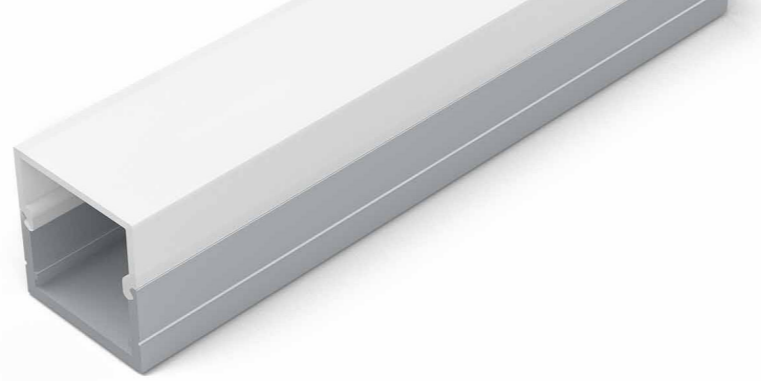

Aluminum Channel w/ LED Strip

**WE U51026 -** Cable LED Strip

Cable Entry

|   |        |
|---|--------|
| F | Front  |
| B | Bottom |
| L | Left   |
| R | Right  |

Please refer to the example on the right page for ordering guideline, and the LED Strip section for the full code of various options of the strips.

Aluminum Channel Only

**WE U51026 - F - PM** Cable

## Mounting Accessory

### WE MP1024

Metal Clip



## Compatible LED Strip Options

| 10mm printed circuit board compatible | Extra Long Strip    |             |              | HE Strip                 |     |      | ECO Strip                |     |      | Tunable White Strip      |     |      |
|---------------------------------------|---------------------|-------------|--------------|--------------------------|-----|------|--------------------------|-----|------|--------------------------|-----|------|
|                                       | 4.8W<br>25m         | 9.6W<br>15m | 14.4W<br>10m | 5m                       |     |      |                          |     |      |                          |     |      |
| Max. Linear Length                    | 4.8                 | 9.6         | 14.4         | 4.8                      | 9.6 | 14.4 | 4.8                      | 9.6 | 14.4 | 4.8                      | 9.6 | 14.4 |
| Power/m (W)                           | 120                 |             |              | 160                      |     |      | 120                      |     |      | 70+70                    |     |      |
| No. of LEDs/m                         | 2700 3000 3500 4000 |             |              | 2400 2700 3000 3500 4000 |     |      | 2400 2700 3000 3500 4000 |     |      | 2700-6500k tunable white |     |      |
| CCT (k)                               | 90+                 |             |              | 90+                      |     |      | 90+                      |     |      | 90+                      |     |      |
| CRI (Ra)                              | WE L61093-.....     |             |              | WE L61075-.....          |     |      | WE L61010-.....          |     |      | WE L61079-.....          |     |      |
| Ordering Code*                        |                     |             |              |                          |     |      |                          |     |      |                          |     |      |

\*Please refer to the LED Strip section for the full ordering code

## Cable

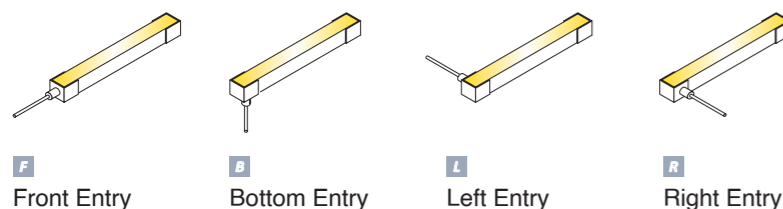

## Ordering Guideline

code of the LED Strip of your choice

**WE U51026 -** Cable **L** - **093** - **90** **3** **0** - **14.4** - **2000**

| Cable Entry | CRI | CCT     | Power      | Length in mm |
|-------------|-----|---------|------------|--------------|
| F Front     | 2   | 7 2700K | 4.8 4.8W   |              |
| B Bottom    | 3   | 0 3000K | 9.6 9.6W   |              |
| L Left      | 3   | 5 3500K | 14.4 14.4W |              |
| R Right     | 4   | 0 4000K |            |              |

Ray-Glow 3-Direction with Left Cable Entry, completed with *Extra Long Strip, Ra90+, 3000K, 14.4W, 2 meters in length*

# Ray-Glow Magnet

- Extruded Aluminum Channel with PC diffuser for LED strip
- Magnet base for easy mounting
- 10mm PCB LED strip compatible
- Customizable length



## Mounting Accessory

### WE MP1025

Metal Clip



Aluminum Channel w/ LED Strip

**WE U51021** - Cable LED Strip

Cable Entry

Please refer to the example on the right page for ordering guideline, and the LED Strip section for the full code of various options of the strips.

F Front

B Bottom

L Left

R Right

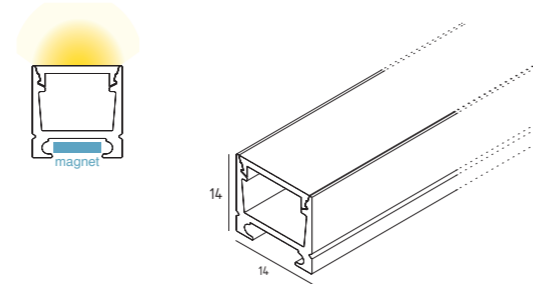

Aluminum Channel Only

**WE U51021 - F - PM** Cable

## Compatible LED Strip Options

| 10mm printed circuit board compatible | Extra Long Strip |             |              | HE Strip        |      |      | ECO Strip       |      |      | Tunable White Strip |      |      |      |      |                          |
|---------------------------------------|------------------|-------------|--------------|-----------------|------|------|-----------------|------|------|---------------------|------|------|------|------|--------------------------|
|                                       | 4.8W<br>25m      | 9.6W<br>15m | 14.4W<br>10m | 5m              |      |      |                 |      |      |                     |      |      |      |      |                          |
| Max. Linear Length                    | 4.8              | 9.6         | 14.4         | 4.8             | 9.6  | 14.4 | 4.8             | 9.6  | 14.4 | 4.8                 | 9.6  | 14.4 |      |      |                          |
| Power/m (W)                           | 120              |             |              | 160             |      |      | 120             |      |      | 70+70               |      |      |      |      |                          |
| No. of LEDs/m                         | 2700             | 3000        | 3500         | 4000            | 2400 | 2700 | 3000            | 3500 | 4000 | 2400                | 2700 | 3000 | 3500 | 4000 | 2700-6500k tunable white |
| CCT (k)                               | 90+              |             |              | 90+             |      |      | 90+             |      |      | 90+                 |      |      |      |      |                          |
| CRI (Ra)                              | WE L61093-.....  |             |              | WE L61075-..... |      |      | WE L61010-..... |      |      | WE L61079-.....     |      |      |      |      |                          |
| Ordering Code*                        |                  |             |              |                 |      |      |                 |      |      |                     |      |      |      |      |                          |

\*Please refer to the LED Strip section for the full ordering code

## Cable

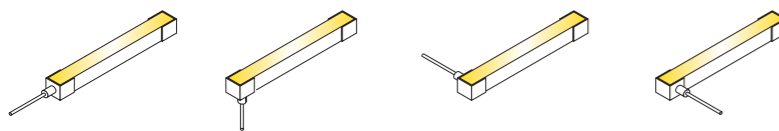

F Front Entry

B Bottom Entry

L Left Entry

R Right Entry

## Ordering Guideline

code of the LED Strip of your choice

**WE U51021** - Cable **L** - **093** - **90** **30** - **14.4** - **2000**

| Cable Entry | CRI | CCT   | Power | Length in mm |
|-------------|-----|-------|-------|--------------|
| F Front     | 27  | 2700K | 4.8   | 4.8W         |
| B Bottom    | 30  | 3000K | 9.6   | 9.6W         |
| L Left      | 35  | 3500K | 14.4  | 14.4W        |
| R Right     | 40  | 4000K |       |              |

Ray-Glow Magnet with Left Cable Entry, completed with **Extra Long Strip, Ra90+, 3000K, 14.4W, 2 meters in length**



# Ray-Glow Thin

- Extruded aluminium profile with PC diffuser for LED strip
- Slim design, 10mm
- 8mm PCB LED strip compatible
- Customizable length



Aluminum Channel w/ LED Strip

**WE U51027** - Cable LED Strip

- Cable Entry
- F** Front
  - B** Bottom
  - L** Left
  - R** Right

Please refer to the example on the right page for ordering guideline, and the LED Strip section for the full code of various options of the strips.

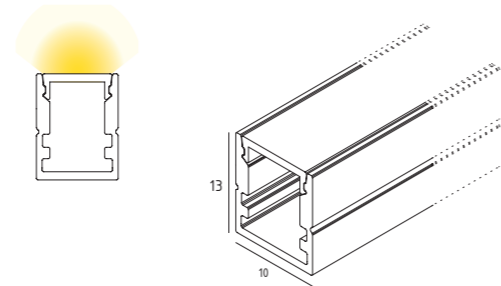

Aluminum Channel Only

**WE U51027 - F - PM** Cable

## Mounting Accessory

**WE MP1026**

Metal Clip

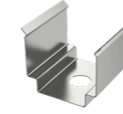

## Compatible LED Strip Options

| 8mm printed circuit board compatible | HE Strip                |      |      | ECO Strip               |      |      | Tunable White Strip     |      |      |      |                          |
|--------------------------------------|-------------------------|------|------|-------------------------|------|------|-------------------------|------|------|------|--------------------------|
|                                      | Max. Linear Length      | 5m   |      |                         |      |      |                         |      |      |      |                          |
| Power/m (W)                          | 4.8                     | 9.6  | 14.4 | 4.8                     | 9.6  | 14.4 | 4.8                     | 9.6  | 14.4 |      |                          |
| No. of LEDs/m                        | 160                     |      |      | 120                     |      |      | 60+60                   |      |      |      |                          |
| CCT (k)                              | 2400                    | 2700 | 3000 | 3500                    | 4000 | 2400 | 2700                    | 3000 | 3500 | 4000 | 2700-6500k tunable white |
| CRI (Ra)                             | 90+                     |      |      | 90+                     |      |      | 90+                     |      |      |      |                          |
| Ordering Code*                       | <b>WE L61102</b> -..... |      |      | <b>WE L61104</b> -..... |      |      | <b>WE L61099</b> -..... |      |      |      |                          |

\*Please refer to the LED Strip section for the full ordering code

## Cable

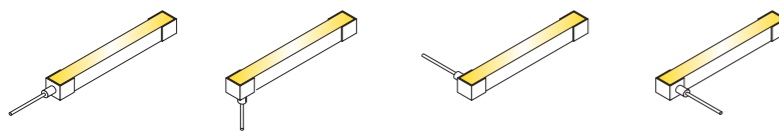

- F** Front Entry
- B** Bottom Entry
- L** Left Entry
- R** Right Entry

## Ordering Guideline

code of the LED Strip of your choice

**WE U61027** - Cable **L** - **102** - **90** **3** **0** - **14.4** - **2000**

| Cable Entry     | CCT              | Power             | Length in mm |
|-----------------|------------------|-------------------|--------------|
| <b>F</b> Front  | <b>2 4</b> 2400K | <b>4.8</b> 4.8W   |              |
| <b>B</b> Bottom | <b>2 7</b> 2700K | <b>9.6</b> 9.6W   |              |
| <b>L</b> Left   | <b>3 0</b> 3000K | <b>14.4</b> 14.4W |              |
| <b>R</b> Right  | <b>3 5</b> 3500K |                   |              |
|                 | <b>4 0</b> 4000K |                   |              |

Ray-Glow Thin with Left Cable Entry, completed with **HE Strip, Ra90+, 3000K, 14.4W, 2 meters in length**



[www.welighting.com](http://www.welighting.com)



WELIGHTING



+852 2359 9866



[mail@welighting.com](mailto:mail@welighting.com)



Unit 01-07, 22/F, CEO Tower,  
77 Wing Hong Street, Lai Chi Kok, Hong Kong

**WELIGHTING**  
[www.welighting.com](http://www.welighting.com)

© 2022 We Lighting Ltd. All rights reserved.