



LEFER
PREMIUM OFFICE LIGHTING

WELIGHTING
SHINE IN A BRIGHTER WAY

LEFER ENERGY SAVING LED TROFFER



Custom made fixtures
for different saving type





Anti-dazzle Design



Energy Saving
LPD < 5w/m²

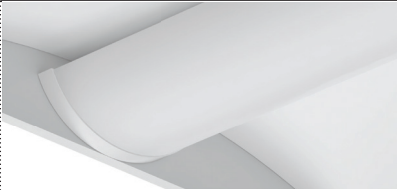
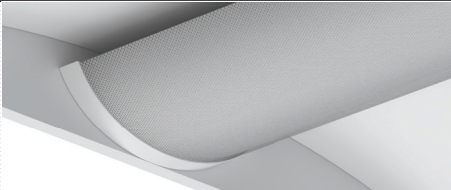

LEFER Product Matrix

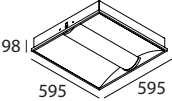
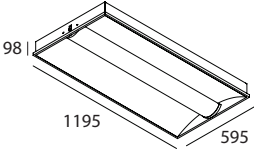
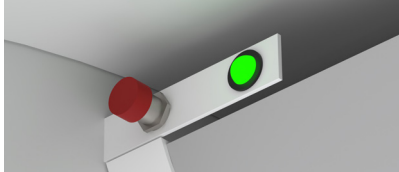
Secondary Diffuser	 <p>Polycarbonate Diffuser</p>	 <p>Perforated Metal Diffuser</p>
Air Slot Availability	 <p>Basic Version</p>	 <p>Air Slot Version air slot cover available for a nicer look</p>
Dimensions	 <p>600mm</p>	 <p>1200mm</p>
Emergency Battery (Optional)	 <p>2 hours/ 3 hours with test button and indicator light</p>	

Project Simulation

<p>366 lux On Floor</p>	<p>Light Power Density 4.98w /m²</p>
------------------------------------	--

Simulation Environment

- Lefer Selection**
1195 x 595, PC Diffuser
- Lefer Spacing**
2.4m x 2.4m
- Ceiling Height**
3m
- Lefer Power**
25.2W

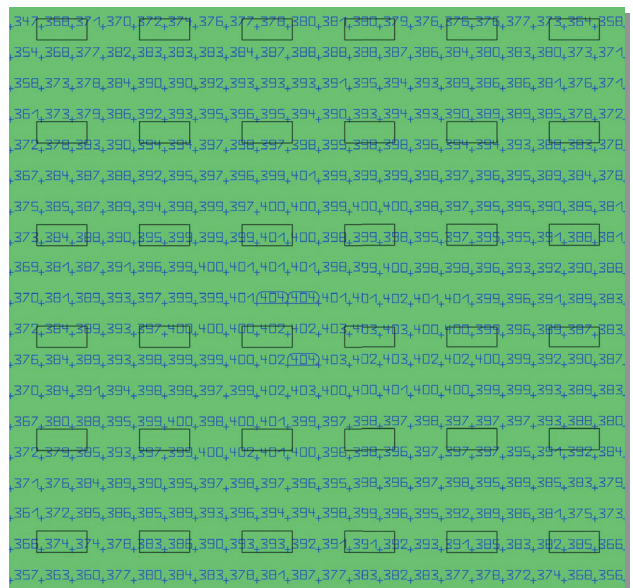

Lux plan on floor

LEFER

- Anti-dazzle design
- High transmission PC diffuser
- Easy-maintenance design
- Zhaga standard
- Custom made trim available for different false ceiling types



Basic Version

WE N71028 - 90 - - **W**

CCT	Power	Dimming
2 7 2700	12.6 12.6W 350mA	N non-dimmable
3 0 3000	18 18W 500mA	D DALI dimmable
4 0 4000		A 0-10V dimmable

- ⚡ SMD Max. 12.6W 350mA 2140lm integrated driver
- ⚡ SMD Max. 18W 500mA, 3058lm, integrated driver

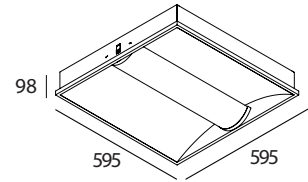

Emergency Battery Version

WE N71028E - 90 - - **W**

CCT	Power	Dimming
2 7 2700	12.6 12.6W 350mA	N non-dimmable
3 0 3000	18 18W 500mA	D DALI dimmable
4 0 4000		A 0-10V dimmable

- ⚡ SMD Max. 12.6W 350mA integrated driver with emergency battery kit
- ⚡ SMD Max. 18W 500mA integrated driver with emergency battery kit



Basic Version

WE N71029 - 90 - - **W**

CCT	Power	Dimming
2 7 2700	25.2 25.2W 700mA	N non-dimmable
3 0 3000	36 36W 1000mA	D DALI dimmable
4 0 4000		A 0-10V dimmable

- ⚡ SMD Max. 25.2W 700mA 4281 lm integrated driver
- ⚡ SMD Max. 36W 1000mA 6116lm integrated driver

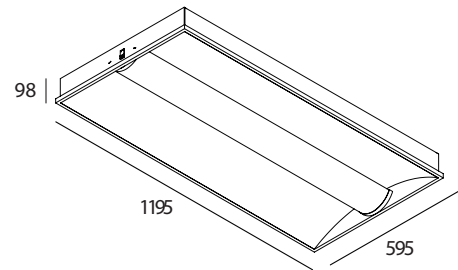

Emergency Battery Version

WE N71029E - 90 - - **W**

CCT	Power	Dimming
2 7 2700	25.2 25.2W 700mA	N non-dimmable
3 0 3000	36 36W 1000mA	D DALI dimmable
4 0 4000		A 0-10V dimmable

- ⚡ SMD Max. 25.2W 700mA integrated driver with emergency battery kit
- ⚡ SMD Max. 36W 1000mA integrated driver with emergency battery kit



Battery Options

Order Code	Battery Operation Time	Emergency Output
EB CC-R24-LED-5-K2	2 hours	180mA
EB CC-R24-LED-5-K3	3 hours	180mA
EB CC-R24-LED-8-K2	2 hours	250mA
EB CC-R24-LED-8-K3	3 hours	250mA

LEFER

- Anti-dazzle design
- High transmission PC diffuser
- Air slots on both sides for plenum ventilation behind false ceilings
- Easy-maintenance design
- Zhaga standard
- Custom made trim available for different false ceiling types



Basic Version

WE N71032 - 90 - **W**

CRI	CCT	Power	Dimming	Color	
2	7	2700	12.6	12.6W 350mA	N non-dimmable
3	0	3000	18	18W 500mA	D DALI dimmable
4	0	4000	A		0-10V dimmable

- ⚡ SMD Max. 12.6W 350mA 2140lm integrated driver
- ⚡ SMD Max. 18W 500mA, 3058lm, integrated driver

Emergency Battery Version

WE N71032E - 90 - **W**

CRI	CCT	Power	Dimming	Color	
2	7	2700	12.6	12.6W 350mA	N non-dimmable
3	0	3000	18	18W 500mA	D DALI dimmable
4	0	4000	A		0-10V dimmable

- ⚡ SMD Max. 12.6W 350mA integrated driver with emergency battery kit
- ⚡ SMD Max. 18W 500mA integrated driver with emergency battery kit

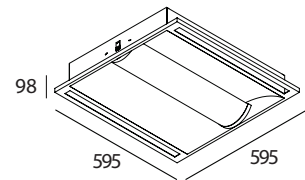

Basic Version

WE N71033 - 90 - **W**

CRI	CCT	Power	Dimming	Color	
2	7	2700	25.2	25.2W 700mA	N non-dimmable
3	0	3000	36	36W 1000mA	D DALI dimmable
4	0	4000	A		0-10V dimmable

- ⚡ SMD Max. 25.2W 700mA 4281 lm integrated driver
- ⚡ SMD Max. 36W 1000mA 6116lm integrated driver

Emergency Battery Version

WE N71033E - 90 - **W**

CRI	CCT	Power	Dimming	Color	
2	7	2700	25.2	25.2W 700mA	N non-dimmable
3	0	3000	36	36W 1000mA	D DALI dimmable
4	0	4000	A		0-10V dimmable

- ⚡ SMD Max. 25.2W 700mA integrated driver with emergency battery kit
- ⚡ SMD Max. 36W 1000mA integrated driver with emergency battery kit

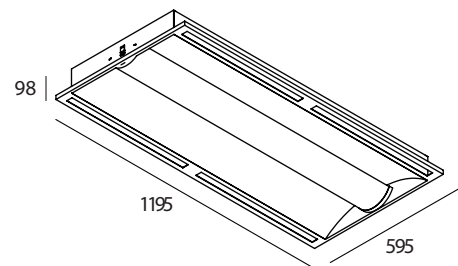

Accessories

WE MP1029-566

Air Slot Cover with Ventilation Slit

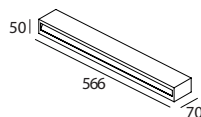

WE MP1030-566

Air Slot Cover

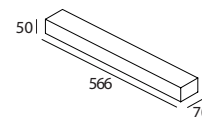

Battery Options

Order Code	Battery Operation Time	Emergency Output
EB CC-R24-LED-5-K2	2 hours	180mA
EB CC-R24-LED-5-K3	3 hours	180mA
EB CC-R24-LED-8-K2	2 hours	250mA
EB CC-R24-LED-8-K3	3 hours	250mA

LEFER Perforated

- Anti-dazzle design
- High Transmission perforated metal diffuser
- Easy-maintenance design
- Zhaga standard
- Custom made trim available for different false ceiling types

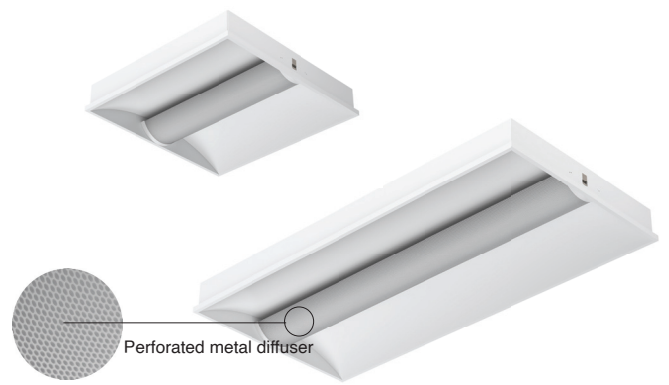

Basic Version

WE N71030 - 90 - W

CRI	CCT	Power	Dimming	Color
2	7	12.6	12.6W 350mA	N
3	0	18	18W 500mA	D
4	0			A

- SMD Max. 12.6W 350mA 2140lm integrated driver
- SMD Max. 18W 500mA, 3058lm, integrated driver

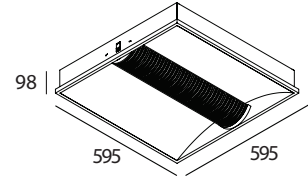

Emergency Battery Version

WE N71030E - 90 - W

CRI	CCT	Power	Dimming	Color
2	7	12.6	12.6W 350mA	N
3	0	18	18W 500mA	D
4	0			A

- SMD Max. 12.6W 350mA integrated driver with emergency battery kit
- SMD Max. 18W 500mA integrated driver with emergency battery kit



Basic Version

WE N71031 - 90 - W

CRI	CCT	Power	Dimming	Color
2	7	25.2	25.2W 700mA	N
3	0	36	36W 1000mA	D
4	0			A

- SMD Max. 25.2W 700mA 4281lm integrated driver
- SMD Max. 36W 1000mA 6116lm integrated driver

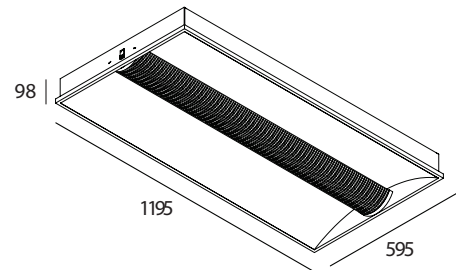

Emergency Battery Version

WE N71031E - 90 - W

CRI	CCT	Power	Dimming	Color
2	7	25.2	25.2W 700mA	N
3	0	36	36W 1000mA	D
4	0			A

- SMD Max. 25.2W 700mA integrated driver with emergency battery kit
- SMD Max. 36W 1000mA integrated driver with emergency battery kit



Battery Options

Order Code	Battery Operation Time	Emergency Output
EB CC-R24-LED-5-K2	2 hours	180mA
EB CC-R24-LED-5-K3	3 hours	180mA
EB CC-R24-LED-8-K2	2 hours	250mA
EB CC-R24-LED-8-K3	3 hours	250mA

LEFER Perforated

- Anti-dazzle design
- High Transmission perforated metal diffuser
- Air slots on both sides for plenum ventilation behind false ceilings
- Easy-maintenance design
- Zhaga standard
- Custom made trim available for different false ceiling types

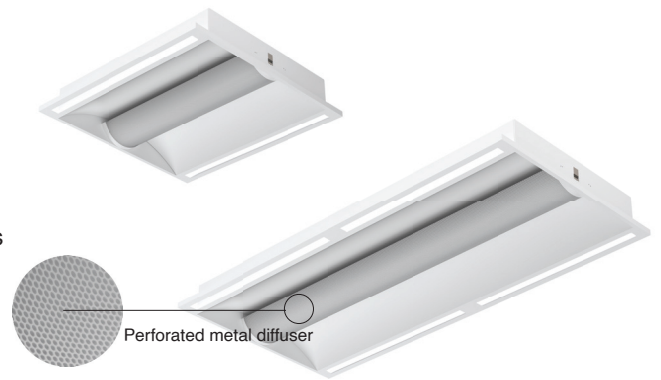

Basic Version

WE N71034 - 90 - **W**

CRI	CCT	Power	Dimming	Color	
2	7	2700	12.6	12.6W 350mA	N non-dimmable
3	0	3000	18	18W 500mA	D DALI dimmable
4	0	4000	A	0-10V dimmable	

- ⚡ SMD Max. 12.6W 350mA 2140lm integrated driver
- ⚡ SMD Max. 18W 500mA 3058lm integrated driver

Emergency Battery Version

WE N71034E - 90 - **W**

CRI	CCT	Power	Dimming	Color	
2	7	2700	12.6	12.6W 350mA	N non-dimmable
3	0	3000	18	18W 500mA	D DALI dimmable
4	0	4000	A	0-10V dimmable	

- ⚡ SMD Max. 12.6W 350mA integrated driver with emergency battery kit
- ⚡ SMD Max. 18W 500mA integrated driver with emergency battery kit

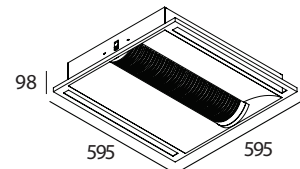

Basic Version

WE N71035 - 90 - **W**

CRI	CCT	Power	Dimming	Color	
2	7	2700	25.2	25.2W 700mA	N non-dimmable
3	0	3000	36	36W 1000mA	D DALI dimmable
4	0	4000	A	0-10V dimmable	

- ⚡ SMD Max. 25.2W 700mA 4281lm integrated driver
- ⚡ SMD Max. 36W 1000mA 6116lm integrated driver

Emergency Battery Version

WE N71035E - 90 - **W**

CRI	CCT	Power	Dimming	Color	
2	7	2700	25.2	25.2W 700mA	N non-dimmable
3	0	3000	36	36W 1000mA	D DALI dimmable
4	0	4000	A	0-10V dimmable	

- ⚡ SMD Max. 25.2W 700mA integrated driver with emergency battery kit
- ⚡ SMD Max. 36W 1000mA integrated driver with emergency battery kit

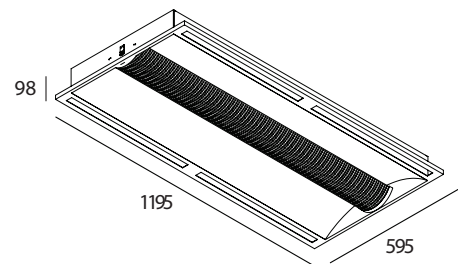

Accessories

WE MP1029-566

Air Slot Cover with Ventilation Slit

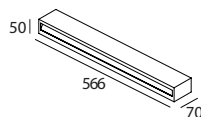

WE MP1030-566

Air Slot Cover

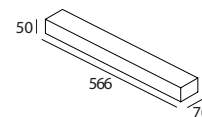

Battery Options

Order Code	Battery Operation Time	Emergency Output
EB CC-R24-LED-5-K2	2 hours	180mA
EB CC-R24-LED-5-K3	3 hours	180mA
EB CC-R24-LED-8-K2	2 hours	250mA
EB CC-R24-LED-8-K3	3 hours	250mA



+852 2359 9866



We Lighting



mail@welighting.com



www.welighting.com



Unit 01-07, 22/F, CEO Tower,
77 Wing Hong Street, Lai Chi Kok, Hong Kong

WELIGHTING
SHINE IN A BRIGHTER WAY

© 2022 We Lighting Ltd. All rights reserved