

# WESS SERIES



**WELIGHTING**

SHINE IN A BRIGHTER WAY



**Beam angle options**

primary optics beam angle options in 15°, 24°, 36°, 55°

**Easy Maintenance Structure**

Everything can access through the cut hole.



Adjustable Fixed

**Small Trim Design**

6mm small trim. Compact and modern architectural design.

**Anti Glare Reflector**

Dark light effect, 5 color options



Dark Chrome Silver Gold Matt White Matt Black

**Changeable Module**

6.8W, 10.3W and 12.2W power package available. CCT and CRI options.



6.8W 10.3W 12.2W

**Accessories Options to be Installed Anytime after Installation**



Honey Comb Louver Linear Spread Lens Soft Lens Vertical Tube

**Trim Options**

Trimless and square trim options  
Flexible to your interior design



round square trimless (round) trimless (square)

**IP 54 Water Proof Options**

Reflector with diffuser also available with IP54 rating



**CIC Green Product - Platinum Certified**

WESS Series\* is awarded Platinum Grade on CIC Green Product Certification issued by Construction Industry Council (CIC) and Hong Kong Green Building Council (HKGBC). We aim to foster sustainable development in the industry.

**CIC GREEN**  
PRODUCT CERTIFICATION  
CICGPC-L-21061(LED)

\*Eligible for specific Models



# WESS Family - Round

Small Trim Version	Trimless Version
	
Trim Color Options	
 Black	 White



Anti-glare Reflector Version	Pin Hole Version
 Dark Chrome	 Pin
 Silver	 Oval
 Gold	
 Matt White	
 Matt Black	



Lamp Source Options	
 COB	 Retrofit MR16



# WESS Family - Square

Small Trim Version	Trimless Version
	
Trim Color Options	
 Black	 White



Anti-glare Reflector Version	Pin Hole Version
 Dark Chrome	 Pin
 Silver	
 Gold	
 Matt White	
 Matt Black	



Lamp Source Options	
 COB	 Retrofit MR16

## Round Trim, Fixed Version

- 6mm die cast aluminum trim
- Polycarbonate secondary anti glare reflector, 5 color option
- Standard with Bridgelux COB; Xicato XOB available on request
- Diffuser on secondary reflector available for IP54 version
- Remote driver, separate order



**CIC GREEN**  
PRODUCT CERTIFICATION  
CIGGPC-L-21061(LED)



### Fixed COB

**WE D31120.**                  

Beam Angle	CRI	CCT	Chips Power / Driving Current / Lumen	Reflector Color
15°	80+	2700K	6.8W / 200mA / 1183lm (CRI80) or 1006lm (CRI90)	Dark Chrome
24°	90+	3000K	10.3W / 300mA / 1792lm (CRI80) or 1524lm (CRI90)	Silver
36°		4000K	12.2W / 350mA / 2013lm (CRI80m) or 1708lm (CRI90)	Gold
55°				Matte White
				Matte Black

### Fixed Retrofit MR16

**WE D31120.R.**      

Gx5.3 max 15W LED  
Retrofit MR16 lamp

Reflector Color
Dark Chrome
Silver
Gold
Matte White
Matte Black

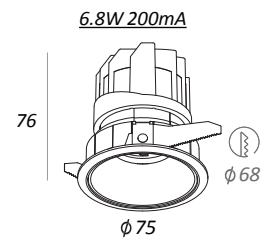

### Diffuser Fixed COB

**WE D31120C.**                  

Beam Angle	CRI	CCT	Chips Power / Driving Current / Lumen	Reflector Color
15°	CRI 80+	2700K	6.8W / 200mA / 1183lm (CRI80) or 1006lm (CRI90)	Dark Chrome
24°	CRI 90+	3000K	10.3W / 300mA / 1792lm (CRI80) or 1524lm (CRI90)	Silver
36°		4000K	12.2W / 350mA / 2013lm (CRI80m) or 1708lm (CRI90)	Gold
55°				Matte White
				Matte Black

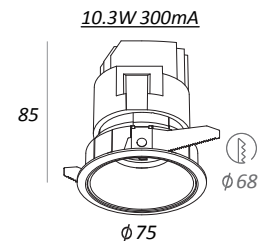

### Diffuser Fixed Retrofit MR16

**WE D31120C.R.**      

Gx5.3 max 15W LED  
Retrofit MR16 lamp

Reflector Color
Dark Chrome
Silver
Gold
Matte White
Matte Black

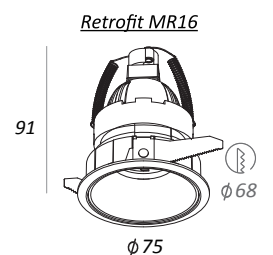
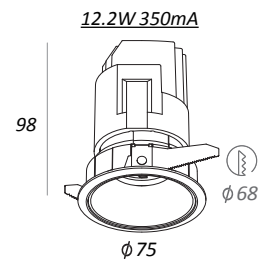

#### REFLECTOR COLOR



#### DRIVER AND ACCESSORIES



# WESS+

## Round Trim, Adjustable Version

- 6mm die cast aluminum trim
- Polycarbonate secondary anti glare reflector, 5 color option
- Standard with Bridgelux COB; Xicato XOB available on request
- Diffuser on secondary reflector available for IP54 version
- Remote driver, separate order



### Adjustable COB



**WE D31124.** [ANGLE] [CRI] [CCT] [POWER] [COLOR]

Beam Angle	CRI	CCT	Chips Power / Driving Current / Lumen	Reflector Color
15°	80+	2700K	6.8W / 200mA / 1183lm (CRI80) or 1006lm (CRI90)	Dark Chrome
24°	90+	3000K	10.3W / 300mA / 1792lm (CRI80) or 1524lm (CRI90)	Silver
36°	4000K	4000K	12.2W / 350mA / 2013lm (CRI80m) or 1708lm (CRI90)	Gold
55°				Matte White
				Matte Black

### Adjustable Retrofit MR16



**WE D31124.R.** [COLOR]

Gx5.3 max 15W LED  
Retrofit MR16 lamp

Reflector Color
Dark Chrome
Silver
Gold
Matte White
Matte Black

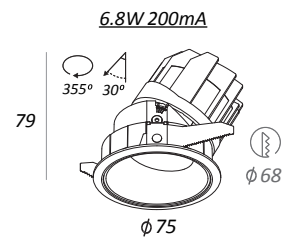

### Diffuser Adjustable COB



**WE D31124C.** [ANGLE] [CRI] [CCT] [POWER] [COLOR]

Beam Angle	CRI	CCT	Chips Power / Driving Current / Lumen	Reflector Color
15°	CRI 80+	2700K	6.8W / 200mA / 1183lm (CRI80) or 1006lm (CRI90)	Dark Chrome
24°	CRI 90+	3000K	10.3W / 300mA / 1792lm (CRI80) or 1524lm (CRI90)	Silver
36°	4000K	4000K	12.2W / 350mA / 2013lm (CRI80m) or 1708lm (CRI90)	Gold
55°				Matte White
				Matte Black

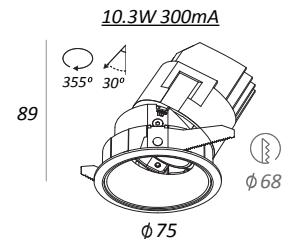

### Diffuser Adjustable Retrofit MR16



**WE D31124C.R.** [COLOR]

Gx5.3 max 15W LED  
Retrofit MR16 lamp

Reflector Color
Dark Chrome
Silver
Gold
Matte White
Matte Black

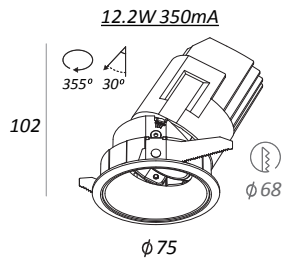

#### REFLECTOR COLOR



#### DRIVER AND ACCESSORIES



see p.22-23 for more detail

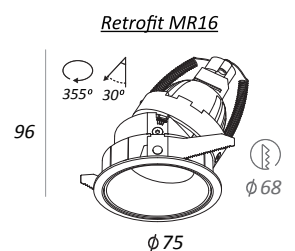

# WESS Pin

## Round Trim, Fixed Pin Version

- 6mm die cast aluminum trim
- Polycarbonate pin hole cover
- Standard with Bridgelux COB; Xicato XOB available on request
- Diffuser on pin hole cover available for IP54 version
- Remote driver, separate order



### Fixed COB

**WE D31122.** [ANGLE] [CRI] [CCT] [POWER] **.W**

BeamAngle	CRI	CCT	Chips Power / Driving Current / Lumen
15°	80+	2700K	6.8W / 200mA / 1183lm (CRI80) or 1006lm (CRI90)
24°	90+	3000K	10.3W / 300mA / 1792lm (CRI80) or 1524lm (CRI90)
36°		4000K	12.2W / 350mA / 2013lm (CRI80m) or 1708lm (CRI90)
55°			

### Fixed Retrofit MR16

**WE D31122.R.W**

Gx5.3 max 15W LED  
Retrofit MR16 lamp

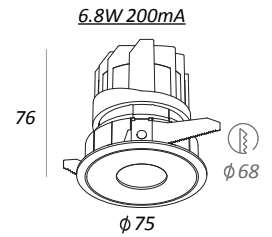

### Diffuser Fixed COB

**WE D31122C.** [ANGLE] [CRI] [CCT] [POWER] **.W**

BeamAngle	CRI	CCT	Chips Power / Driving Current / Lumen
15°	80+	2700K	6.8W / 200mA / 1183lm (CRI80) or 1006lm (CRI90)
24°	90+	3000K	10.3W / 300mA / 1792lm (CRI80) or 1524lm (CRI90)
36°		4000K	12.2W / 350mA / 2013lm (CRI80m) or 1708lm (CRI90)
55°			

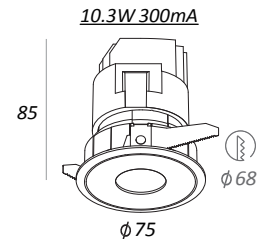

### Diffuser Fixed Retrofit MR16

**WE D31122C.R.W**

Gx5.3 max 15W LED  
Retrofit MR16 lamp

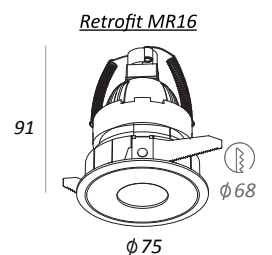
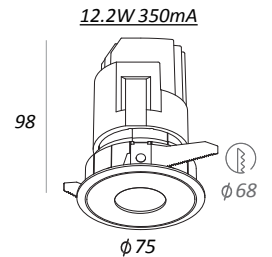

### DRIVER AND ACCESSORIES



see p.22-23 for more detail





# WESS TL

## Round Trimless, Fixed Version

- Trimless fitting with trimless installation kit
- Polycarbonate secondary anti glare reflector, 5 color option
- Standard with Bridgelux COB; Xicato XOB available on request
- Diffuser on secondary reflector available for IP54 version
- Remote driver, separate order



### Fixed COB

**WE D31130.** ANGLE . CRI . CCT . POWER . COLOR

Beam Angle	CRI	CCT	Chips Power / Driving Current / Lumen	Reflector Color
15°	80+	2700K	6.8W / 200mA / 1183lm (CRI80) or 1006lm (CRI90)	Dark Chrome
24°	90+	3000K	10.3W / 300mA / 1792lm (CRI80) or 1524lm (CRI90)	Silver
36°	4000K	4000K	12.2W / 350mA / 2013lm (CRI80m) or 1708lm (CRI90)	Gold
55°				Matte White
				Matte Black

### Fixed Retrofit MR16

**WE D31130.R.** COLOR

Gx5.3 max 15W LED  
Retrofit MR16 lamp

Reflector Color
Dark Chrome
Silver
Gold
Matte White
Matte Black

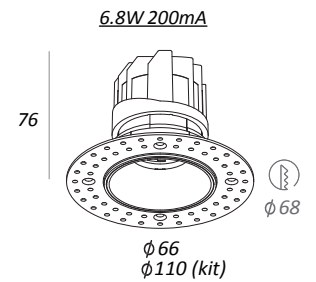

### Diffuser Fixed COB

**WE D31130C.** ANGLE . CRI . CCT . POWER . COLOR

Beam Angle	CRI	CCT	Chips Power / Driving Current / Lumen	Reflector Color
15°	CRI 80+	2700K	6.8W / 200mA / 1183lm (CRI80) or 1006lm (CRI90)	Dark Chrome
24°	CRI 90+	3000K	10.3W / 300mA / 1792lm (CRI80) or 1524lm (CRI90)	Silver
36°	4000K	4000K	12.2W / 350mA / 2013lm (CRI80m) or 1708lm (CRI90)	Gold
55°				Matte White
				Matte Black

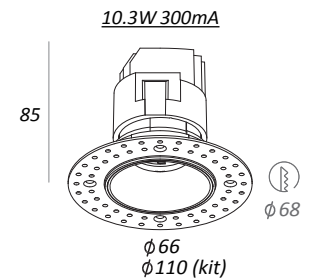

### Diffuser Fixed Retrofit MR16

**WE D31130C.R.** COLOR

Gx5.3 max 15W LED  
Retrofit MR16 lamp

Reflector Color
Dark Chrome
Silver
Gold
Matte White
Matte Black

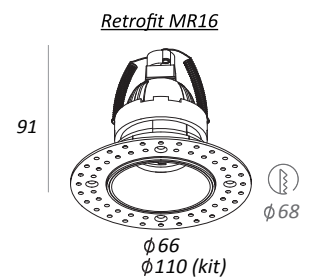
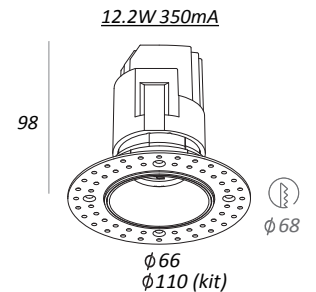

#### REFLECTOR COLOR



#### DRIVER AND ACCESSORIES



# WESS+ TL

## Round Trimless, Adjustable Version

- Trimless fitting with trimless installation kit
- Polycarbonate secondary anti glare reflector, 5 color option
- Standard with Bridgelux COB; Xicato XOB available on request
- Diffuser on secondary reflector available for IP54 version
- Remote driver, separate order

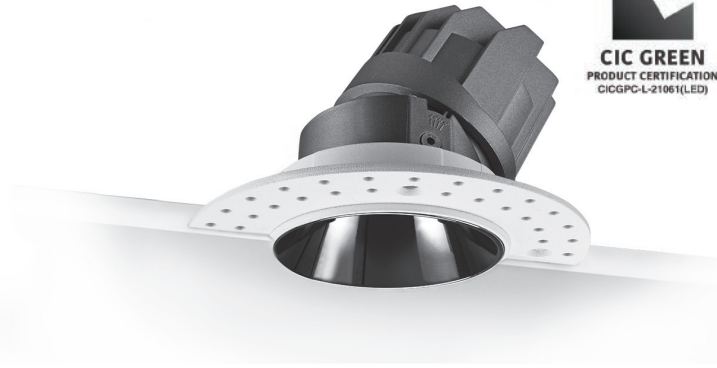

### Adjustable COB

**WE D31134.**

BeamAngle	CRI	CCT	Chips Power / Driving Current / Lumen	Reflector Color
15°	80+	2700K	6.8W / 200mA / 1183lm (CRI80) or 1006lm (CRI90)	Dark Chrome
24°	90+	3000K	10.3W / 300mA / 1792lm (CRI80) or 1524lm (CRI90)	Silver
36°	4000K	4000K	12.2W / 350mA / 2013lm (CRI80m) or 1708lm (CRI90)	Gold
55°				Matte White
				Matte Black

### Adjustable Retrofit MR16

**WE D31134.R.**

Gx5.3 max 15W LED  
Retrofit MR16 lamp

Reflector Color
Dark Chrome
Silver
Gold
Matte White
Matte Black

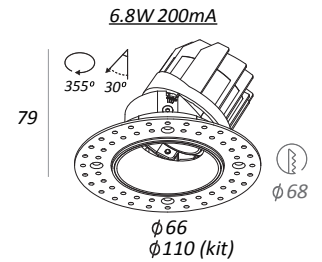

### Diffuser Adjustable COB

**WE D31134C.**

BeamAngle	CRI	CCT	Chips Power / Driving Current / Lumen	Reflector Color
15°	CRI 80+	2700K	6.8W / 200mA / 1183lm (CRI80) or 1006lm (CRI90)	Dark Chrome
24°	CRI 90+	3000K	10.3W / 300mA / 1792lm (CRI80) or 1524lm (CRI90)	Silver
36°	4000K	4000K	12.2W / 350mA / 2013lm (CRI80m) or 1708lm (CRI90)	Gold
55°				Matte White
				Matte Black

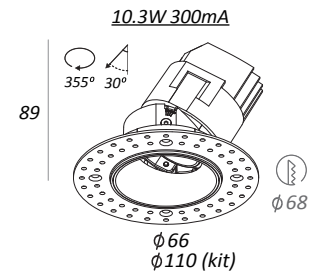

### Diffuser Adjustable Retrofit MR16

**WE D31134C.R.**

Gx5.3 max 15W LED  
Retrofit MR16 lamp

Reflector Color
Dark Chrome
Silver
Gold
Matte White
Matte Black

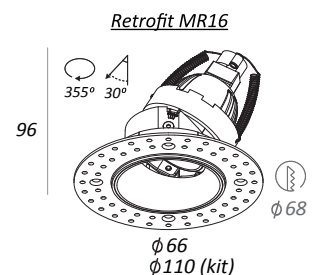
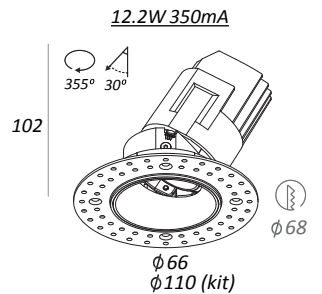

#### REFLECTOR COLOR



#### DRIVER AND ACCESSORIES



see p.22-23 for more detail





# WESS S

## Square Trim, Fixed Version

- 6mm die cast aluminum trim
- Polycarbonate secondary anti glare reflector, 5 color option
- Standard with Bridgelux COB; Xicato XOB available on request
- Diffuser on secondary reflector available for IP54 version
- Remote driver, separate order



### Fixed COB

**WE D31140.** [ ] [ ] [ ] [ ] [ ] [ ]

BeamAngle	CRI	CCT	Chips Power / Driving Current / Lumen	Reflector Color
15°	80+	2700K	6.8W / 200mA / 1183lm (CRI80) or 1006lm (CRI90)	Dark Chrome
24°	90+	3000K	10.3W / 300mA / 1792lm (CRI80) or 1524lm (CRI90)	Silver
36°	4000K	4000K	12.2W / 350mA / 2013lm (CRI80m) or 1708lm (CRI90)	Gold
55°				Matte White
				Matte Black

### Fixed Retrofit MR16

**WE D31140.R.** [ ] [ ] [ ] [ ] [ ] [ ]

Reflector Color
Dark Chrome
Silver
Gold
Matte White
Matte Black

Gx5.3 max 15W LED  
Retrofit MR16 lamp

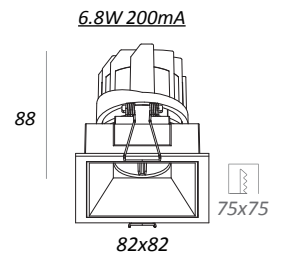

### Diffuser Fixed COB

**WE D31140C.** [ ] [ ] [ ] [ ] [ ] [ ]

BeamAngle	CRI	CCT	Chips Power / Driving Current / Lumen	Reflector Color
15°	CRI 80+	2700K	6.8W / 200mA / 1183lm (CRI80) or 1006lm (CRI90)	Dark Chrome
24°	CRI 90+	3000K	10.3W / 300mA / 1792lm (CRI80) or 1524lm (CRI90)	Silver
36°	4000K	4000K	12.2W / 350mA / 2013lm (CRI80m) or 1708lm (CRI90)	Gold
55°				Matte White
				Matte Black

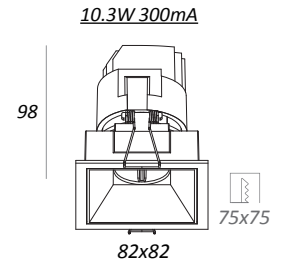

### Diffuser Fixed Retrofit MR16

**WE D31140C.R.** [ ] [ ] [ ] [ ] [ ] [ ]

Reflector Color
Dark Chrome
Silver
Gold
Matte White
Matte Black

Gx5.3 max 15W LED  
Retrofit MR16 lamp

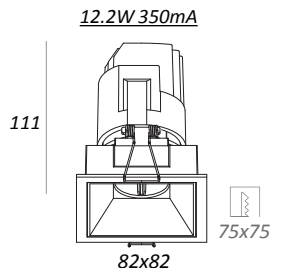

#### REFLECTOR COLOR



#### DRIVER AND ACCESSORIES

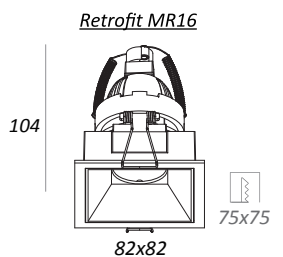

# WESS+ S

## Square Trim, Adjustable Version

- 6mm die cast aluminum trim
- Polycarbonate secondary anti glare reflector, 5 color option
- Standard with Bridgelux COB; Xicato XOB available on request
- Diffuser on secondary reflector available for IP54 version
- Remote driver, separate order



### Adjustable COB

**WE D31144.** [ANGLE] [CRI] [CCT] [POWER] [COLOR]

BeamAngle	CRI	CCT	Chips Power / Driving Current / Lumen	Reflector Color
15°	80+	2700K	6.8W / 200mA / 1183lm (CRI80) or 1006lm (CRI90)	Dark Chrome
24°	90+	3000K	10.3W / 300mA / 1792lm (CRI80) or 1524lm (CRI90)	Silver
36°	4000K	4000K	12.2W / 350mA / 2013lm (CRI80m) or 1708lm (CRI90)	Gold
55°				Matte White
				Matte Black

### Adjustable Retrofit MR16

**WE D31144.R.** [COLOR]

Gx5.3 max 15W LED  
Retrofit MR16 lamp

Reflector Color
Dark Chrome
Silver
Gold
Matte White
Matte Black

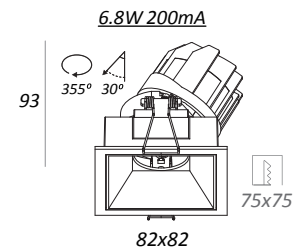

### Diffuser Adjustable COB

**WE D31144C.** [ANGLE] [CRI] [CCT] [POWER] [COLOR]

BeamAngle	CRI	CCT	Chips Power / Driving Current / Lumen	Reflector Color
15°	CRI 80+	2700K	6.8W / 200mA / 1183lm (CRI80) or 1006lm (CRI90)	Dark Chrome
24°	CRI 90+	3000K	10.3W / 300mA / 1792lm (CRI80) or 1524lm (CRI90)	Silver
36°	4000K	4000K	12.2W / 350mA / 2013lm (CRI80m) or 1708lm (CRI90)	Gold
55°				Matte White
				Matte Black

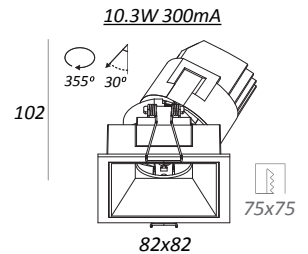

### Diffuser Adjustable Retrofit MR16

**WE D31144C.R.** [COLOR]

Gx5.3 max 15W LED  
Retrofit MR16 lamp

Reflector Color
Dark Chrome
Silver
Gold
Matte White
Matte Black

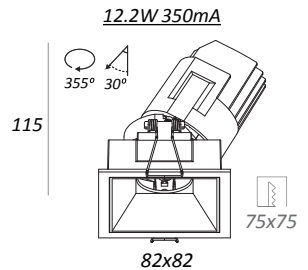

#### REFLECTOR COLOR



#### DRIVER AND ACCESSORIES



see p.22-23 for more detail

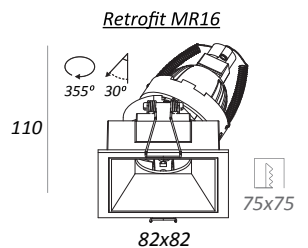

# WESS S Pin

## Square Trim, Fixed Pin Version

- 6mm die cast aluminum trim
- Polycarbonate pin hole cover
- Standard with Bridgelux COB; Xicato XOB available on request
- Diffuser on pin hole cover available for IP54 version
- Remote driver, separate order



**CIC GREEN**  
PRODUCT CERTIFICATION  
CICGPC-L-21061(LED)



### Fixed COB

**WE D31142.** [ANGLE] [CRI] [CCT] [POWER] **.W**

BeamAngle	CRI	CCT	Chips Power / Driving Current / Lumen
15°	80+	2700K	6.8W / 200mA / 1183lm (CRI80) or 1006lm (CRI90)
24°	90+	3000K	10.3W / 300mA / 1792lm (CRI80) or 1524lm (CRI90)
36°		4000K	12.2W / 350mA / 2013lm (CRI80m) or 1708lm (CRI90)
55°			

### Fixed Retrofit MR16

**WE D31142.R.W**

Gx5.3 max 15W LED  
Retrofit MR16 lamp

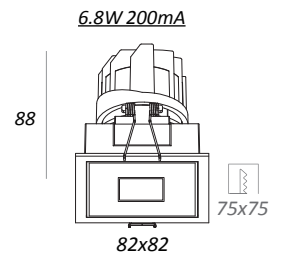

### Diffuser Fixed COB

**WE D31142C.** [ANGLE] [CRI] [CCT] [POWER] **.W**

BeamAngle	CRI	CCT	Chips Power / Driving Current / Lumen
15°	80+	2700K	6.8W / 200mA / 1183lm (CRI80) or 1006lm (CRI90)
24°	90+	3000K	10.3W / 300mA / 1792lm (CRI80) or 1524lm (CRI90)
36°		4000K	12.2W / 350mA / 2013lm (CRI80m) or 1708lm (CRI90)
55°			

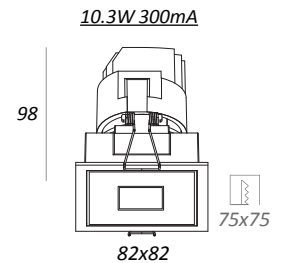

### Diffuser Fixed Retrofit MR16

**WE D31142C.R.W**

Gx5.3 max 15W LED  
Retrofit MR16 lamp

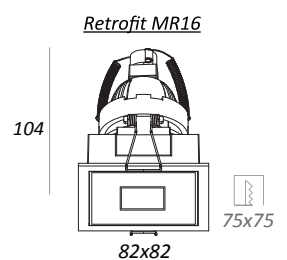
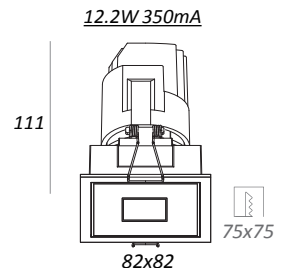

### DRIVER AND ACCESSORIES



see p.22-23 for more detail

# WESS+ S Pin

## Square Trim, Adjustable Pin Version

- 6mm die cast aluminum trim
- Polycarbonate pin hole cover
- Standard with Bridgelux COB; Xicato XOB available on request
- Diffuser on pin hole cover available for IP54 version
- Remote driver, separate order



**CIC GREEN**  
PRODUCT CERTIFICATION  
CICGPC-L-21061(LED)

### Adjustable COB



**WE D31146.** [ANGLE] [CRI] [CCT] [POWER] **.W**

BeamAngle	CRI	CCT	Chips Power / Driving Current / Lumen
15°	80+	2700K	6.8W / 200mA / 1183lm (CRI80) or 1006lm (CRI90)
24°	90+	3000K	10.3W / 300mA / 1792lm (CRI80) or 1524lm (CRI90)
36°	4000K	12.2W / 350mA / 2013lm (CRI80m) or 1708lm (CRI90)	
55°			

### Adjustable Retrofit MR16



**WE D31146.R.W**

Gx5.3 max 15W LED  
Retrofit MR16 lamp

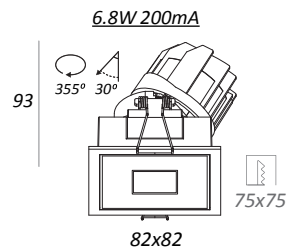

### Diffuser Adjustable COB



**WE D31146C.** [ANGLE] [CRI] [CCT] [POWER] **.W**

BeamAngle	CRI	CCT	Chips Power / Driving Current / Lumen
15°	80+	2700K	6.8W / 200mA / 1183lm (CRI80) or 1006lm (CRI90)
24°	90+	3000K	10.3W / 300mA / 1792lm (CRI80) or 1524lm (CRI90)
36°	4000K	12.2W / 350mA / 2013lm (CRI80m) or 1708lm (CRI90)	
55°			

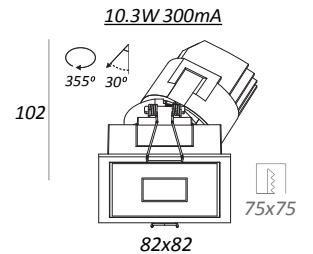

### Diffuser Adjustable Retrofit MR16



**WE D31146C.R.W**

Gx5.3 max 15W LED  
Retrofit MR16 lamp

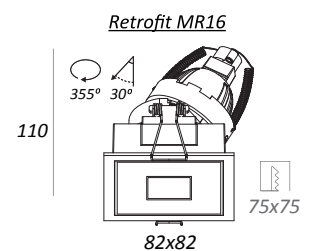
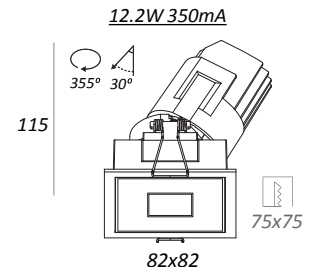

### DRIVER AND ACCESSORIES



see p.22-23 for more detail



# WESS TL

## Square Trimless, Fixed Version

- Trimless fitting with trimless installation kit
- Polycarbonate secondary anti glare reflector, 5 color option
- Standard with Bridgelux COB; Xicato XOB available on request
- Diffuser on secondary reflector available for IP54 version
- Remote driver, separate order



### Fixed COB

**WE D31150.**

BeamAngle	CRI	CCT	Chips Power / Driving Current / Lumen	Reflector Color
<input type="text"/> <input type="text"/> 15°	<input type="text"/> <input type="text"/> 80+	<input type="text"/> <input type="text"/> 2700K	<input type="text"/> 6.8W / 200mA / 1183lm (CRI80) or 1006lm (CRI90)	<input type="text"/> <input type="text"/> Dark Chrome
<input type="text"/> <input type="text"/> 24°	<input type="text"/> <input type="text"/> 90+	<input type="text"/> <input type="text"/> 3000K	<input type="text"/> <input type="text"/> 10.3W / 300mA / 1792lm (CRI80) or 1524lm (CRI90)	<input type="text"/> <input type="text"/> Silver
<input type="text"/> <input type="text"/> 36°	<input type="text"/> <input type="text"/> 4000K	<input type="text"/> <input type="text"/> 12.2W / 350mA / 2013lm (CRI80m) or 1708lm (CRI90)		<input type="text"/> <input type="text"/> Gold
<input type="text"/> <input type="text"/> 55°				<input type="text"/> <input type="text"/> Matte White
				<input type="text"/> <input type="text"/> Matte Black

### Fixed Retrofit MR16

**WE D31150.R.**

Reflector Color
<input type="text"/> <input type="text"/> Dark Chrome
<input type="text"/> <input type="text"/> Silver
<input type="text"/> <input type="text"/> Gold
<input type="text"/> <input type="text"/> Matte White
<input type="text"/> <input type="text"/> Matte Black

Gx5.3 max 15W LED  
Retrofit MR16 lamp

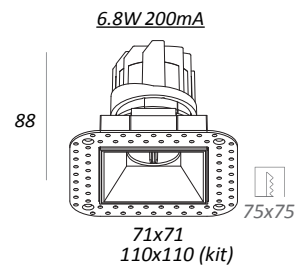

### Diffuser Fixed COB

**WE D31150C.**

BeamAngle	CRI	CCT	Chips Power / Driving Current / Lumen	Reflector Color
<input type="text"/> <input type="text"/> 15°	<input type="text"/> <input type="text"/> CRI 80+	<input type="text"/> <input type="text"/> 2700K	<input type="text"/> 6.8W / 200mA / 1183lm (CRI80) or 1006lm (CRI90)	<input type="text"/> <input type="text"/> Dark Chrome
<input type="text"/> <input type="text"/> 24°	<input type="text"/> <input type="text"/> CRI 90+	<input type="text"/> <input type="text"/> 3000K	<input type="text"/> <input type="text"/> 10.3W / 300mA / 1792lm (CRI80) or 1524lm (CRI90)	<input type="text"/> <input type="text"/> Silver
<input type="text"/> <input type="text"/> 36°	<input type="text"/> <input type="text"/> 4000K	<input type="text"/> <input type="text"/> 12.2W / 350mA / 2013lm (CRI80m) or 1708lm (CRI90)		<input type="text"/> <input type="text"/> Gold
<input type="text"/> <input type="text"/> 55°				<input type="text"/> <input type="text"/> Matte White
				<input type="text"/> <input type="text"/> Matte Black

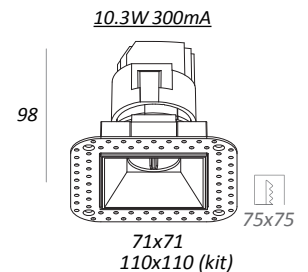

### Diffuser Fixed Retrofit MR16

**WE D31150C.R.**

Reflector Color
<input type="text"/> <input type="text"/> Dark Chrome
<input type="text"/> <input type="text"/> Silver
<input type="text"/> <input type="text"/> Gold
<input type="text"/> <input type="text"/> Matte White
<input type="text"/> <input type="text"/> Matte Black

Gx5.3 max 15W LED  
Retrofit MR16 lamp

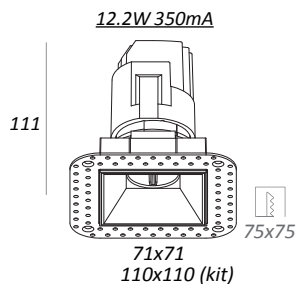

#### REFLECTOR COLOR



#### DRIVER AND ACCESSORIES

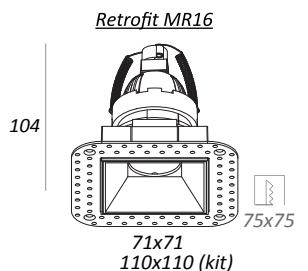

# WESS+ S TL

## Square Trimless, Adjustable Version

- Trimless fitting with trimless installation kit
- Polycarbonate secondary anti glare reflector, 5 color option
- Standard with Bridgelux COB; Xicato XOB available on request
- Diffuser on secondary reflector available for IP54 version
- Remote driver, separate order



**CIC GREEN**  
PRODUCT CERTIFICATION  
CICGPC-L-21061(LED)

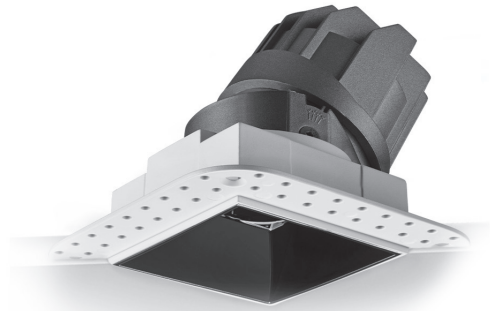

### Adjustable COB

**WE D31154.**

BeamAngle	CRI	CCT	Chips Power / Driving Current / Lumen	Reflector Color
15°	80+	2700K	6.8W / 200mA / 1183lm (CRI80) or 1006lm (CRI90)	Dark Chrome
24°	90+	3000K	10.3W / 300mA / 1792lm (CRI80) or 1524lm (CRI90)	Silver
36°	4000K	4000K	12.2W / 350mA / 2013lm (CRI80m) or 1708lm (CRI90)	Gold
55°				Matte White
				Matte Black

### Adjustable Retrofit MR16

**WE D31154.R.**

COLOR	Reflector Color
WD	Dark Chrome
WS	Silver
WG	Gold
WW	Matte White
WB	Matte Black

Gx5.3 max 15W LED  
Retrofit MR16 lamp

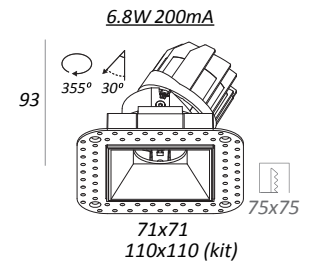

### Diffuser Adjustable COB

**WE D31154C.**

BeamAngle	CRI	CCT	Chips Power / Driving Current / Lumen	Reflector Color
15°	CRI 80+	2700K	6.8W / 200mA / 1183lm (CRI80) or 1006lm (CRI90)	Dark Chrome
24°	CRI 90+	3000K	10.3W / 300mA / 1792lm (CRI80) or 1524lm (CRI90)	Silver
36°	4000K	4000K	12.2W / 350mA / 2013lm (CRI80m) or 1708lm (CRI90)	Gold
55°				Matte White
				Matte Black

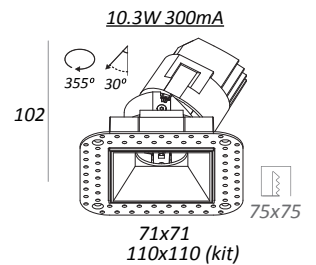

### Diffuser Adjustable Retrofit MR16

**WE D31154C.R.**

COLOR	Reflector Color
WD	Dark Chrome
WS	Silver
WG	Gold
WW	Matte White
WB	Matte Black

Gx5.3 max 15W LED  
Retrofit MR16 lamp

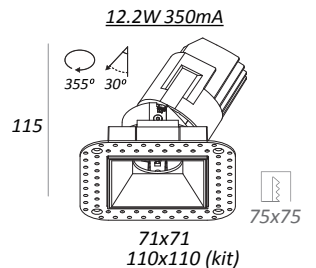

#### REFLECTOR COLOR



#### DRIVER AND ACCESSORIES

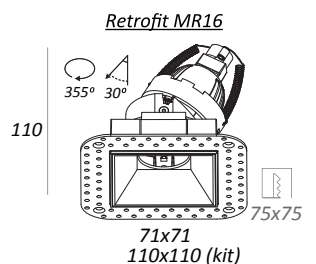

# WESS S TL Pin

## Square Trimless, Fixed Pin Version

- Trimless fitting with trimless installation kit
- Polycarbonate pin hole cover
- Standard with Bridgelux COB; Xicato XOB available on request
- Diffuser on pin hole cover available for IP54 version
- Remote driver, separate order



### Fixed COB

**WE D31152.** [ ] [ ] [ ] [ ] [ ] **W**

BeamAngle	CRI	CCT	Chips Power / Driving Current / Lumen
15°	80+	2700K	6.8W / 200mA / 1183lm (CRI80) or 1006lm (CRI90)
24°	90+	3000K	10.3W / 300mA / 1792lm (CRI80) or 1524lm (CRI90)
36°		4000K	12.2W / 350mA / 2013lm (CRI80m) or 1708lm (CRI90)
55°			

### Fixed Retrofit MR16

**WE D31152.R.W**

Gx5.3 max 15W LED  
Retrofit MR16 lamp

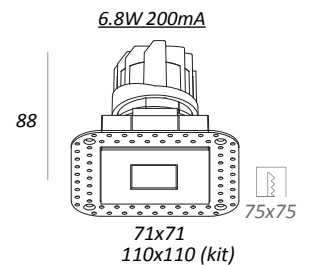

### Diffuser Fixed COB

**WE D31152C.** [ ] [ ] [ ] [ ] [ ] **.W**

BeamAngle	CRI	CCT	Chips Power / Driving Current / Lumen
15°	CRI 80+	2700K	6.8W / 200mA / 1183lm (CRI80) or 1006lm (CRI90)
24°	CRI 90+	3000K	10.3W / 300mA / 1792lm (CRI80) or 1524lm (CRI90)
36°		4000K	12.2W / 350mA / 2013lm (CRI80m) or 1708lm (CRI90)
55°			

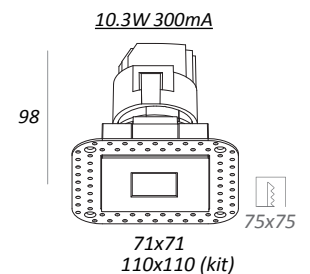

### Diffuser Fixed Retrofit MR16

**WE D31152C.R.W**

Gx5.3 max 15W LED  
Retrofit MR16 lamp

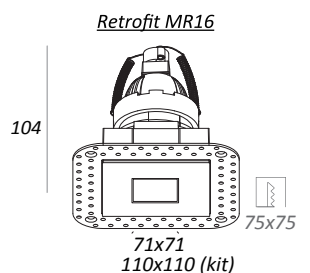
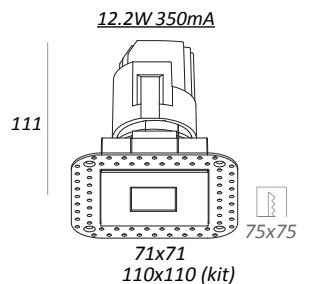

### DRIVER AND ACCESSORIES



see p.22-23 for more detail



# WESS Accessories

**WE D91040**  
Honey Comb Louver



**WE D91041**  
Spread Lens







**WE D91042**  
Linear Spread Lens



**WE D91043**  
Vertical Tube



# Constant Current Driver

Order Code	Driving Power Range	Output Current	Wiring Box Dimension L x W x H (mm)	Required Cut Hole diameter (mm)
<b><i>TD EG-200mA-8N-LS1(01)</i></b>	6W - 8.4W	200mA	180 x 40 x 30 	ø55
<b><i>TD LT-SETmA-10D-AD1(01)</i></b>	2W - 8.4W	200mA 1-10V dimmable	180 x 40 x 30 	ø55
<b><i>TD EG-300mA-12N-LS3(01)</i></b>	9W - 12W	300mA	180 x 40 x 30 	ø55
<b><i>TD LT-SETmA-15D-AD2(02)</i></b>	3.2W - 15W	300mA 1-10V dimmable	260 x 50 x 40 	ø64
<b><i>TD EG-350mA-12N-LS3(01)</i></b>	10.5W - 14W	350mA	180 x 40 x 30 	ø55
<b><i>TD LT-SETmA-15D-AD2(02)</i></b>	3.5W - 14.7W	350mA 1-10V dimmable	260 x 50 x 40 	ø64

# Retrofit MR16

## Philips Expert Color

- Nominal Life 40K hrs, L70
- 7.2W dimmable
- CRI 97
- Color consistency <3 Steps SDCM

**LB M. EXP.**

CRI / CRT			
-----------	--	--	--

 - **7.2** - 

ANGLE			
-------	--	--	--

**B-PH**

CRI			
9	2	7	2700k
9	3	0	3000k
9	4	0	4000k

Beam Angle		
2	4	24°
3	6	36°



## Philips Master LED

- Nominal Life 40K hrs, L70
- 6.5W dimmable
- CRI 90+
- Color consistency <4 Steps SDCM

**LB M. MAT.**

CRI / CRT			
-----------	--	--	--

 - **6.5** - 

ANGLE			
-------	--	--	--

**B-PH**

CRI			
9	2	7	2700k
9	3	0	3000k
9	4	0	4000k

Beam Angle		
2	4	24°
3	6	36°



## Philips MAS LED Spot Value

- Nominal Life 25K hrs, L70
- 5.5W or 7W dimmable
- CRI 80+

**LB M. MAS.**

CRI / CRT			
-----------	--	--	--

 - 

POWER		
-------	--	--

 - 

ANGLE			
-------	--	--	--

**B-PH**

CRI			
9	2	7	2700k
9	3	0	3000k
9	4	0	4000k

Power	
5.5	5.5
7	7

Beam Angle		
3	6	36°
6	0	60°



# 12V Step Down Transformer for Retrofit MR16

Order Code	Driving Power Range	Output Current	Wiring Box Dimension L x W x H (mm)	Required Cut Hole diameter (mm)
<b>TD PH-12V-10P-ETE(03)</b>	Max 10W 1pce of Retrofit	12V Phase Dimmable	150 x 57 x 32 	ø64

# WESS Photometrics Data

- Photometric Data are for reference only
- Data will be slightly vary in using accessories and color of reflector
- All data measure from 4000K module, fixed round fitting, silver reflector

**6.8W**

200 mA

**CRI 80**

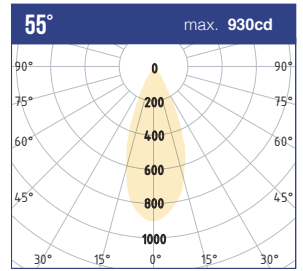
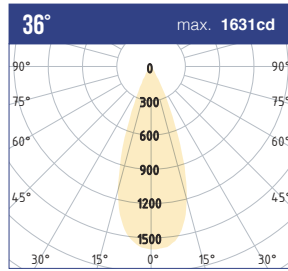
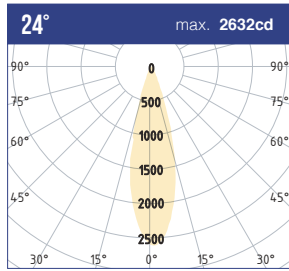
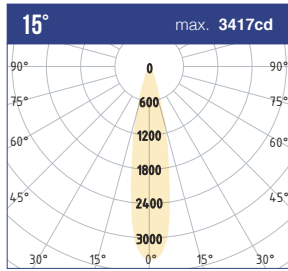

**CRI 90**

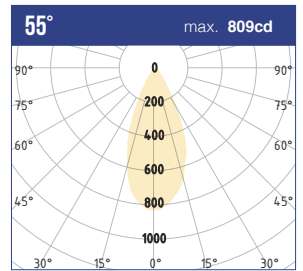
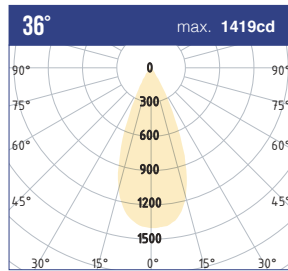
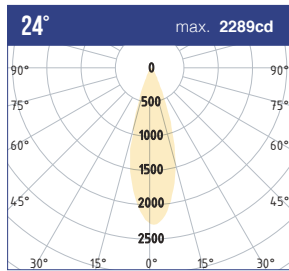
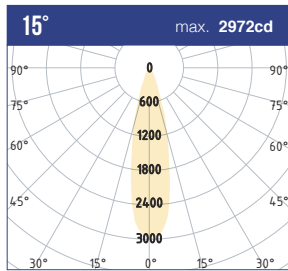

**10.3W**

300 mA

**CRI 80**

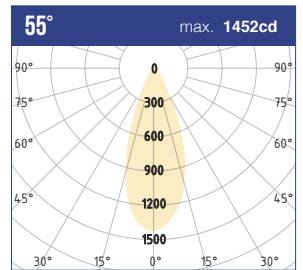
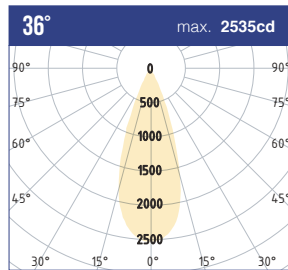
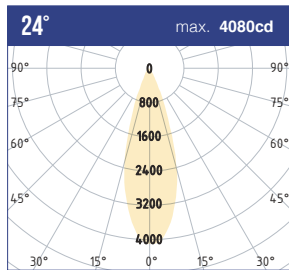
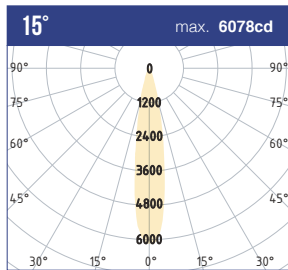

**CRI 90**

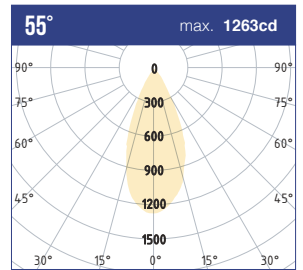
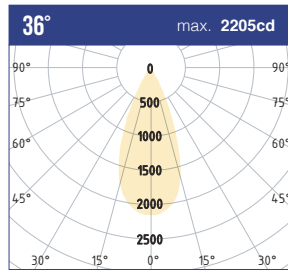
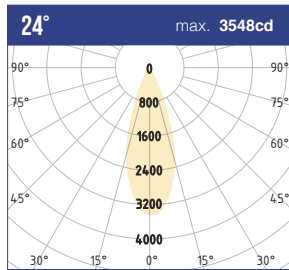
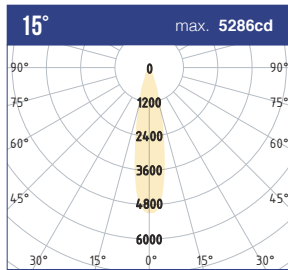

**12.2W**

350 mA

**CRI 80**

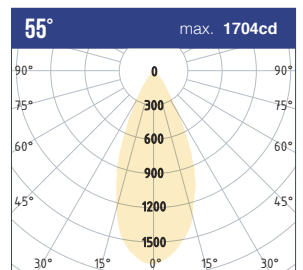
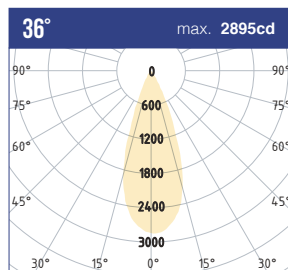
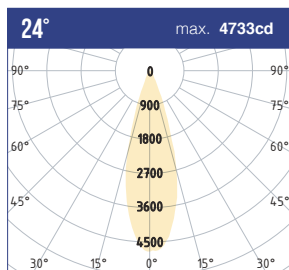
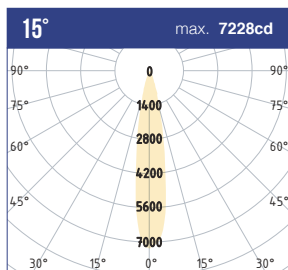

**CRI 90**

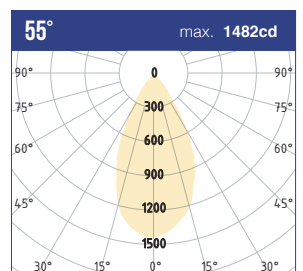
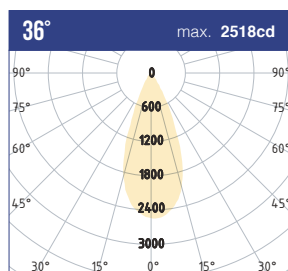
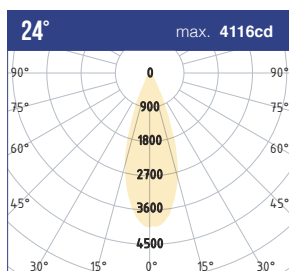
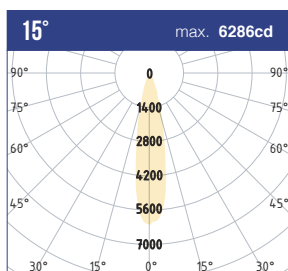



[www.welighting.com](http://www.welighting.com)



WELIGHTING



+852 2359 9866



[mail@welighting.com](mailto:mail@welighting.com)



Unit 01-07, 22/F, CEO Tower,  
77 Wing Hong Street, Lai Chi Kok, Hong Kong

**WELIGHTING**

[www.welighting.com](http://www.welighting.com)

© 2022 We Lighting Ltd. All rights reserved.