

PAVEL SERIES

Motorized Remote Controlled Lighting

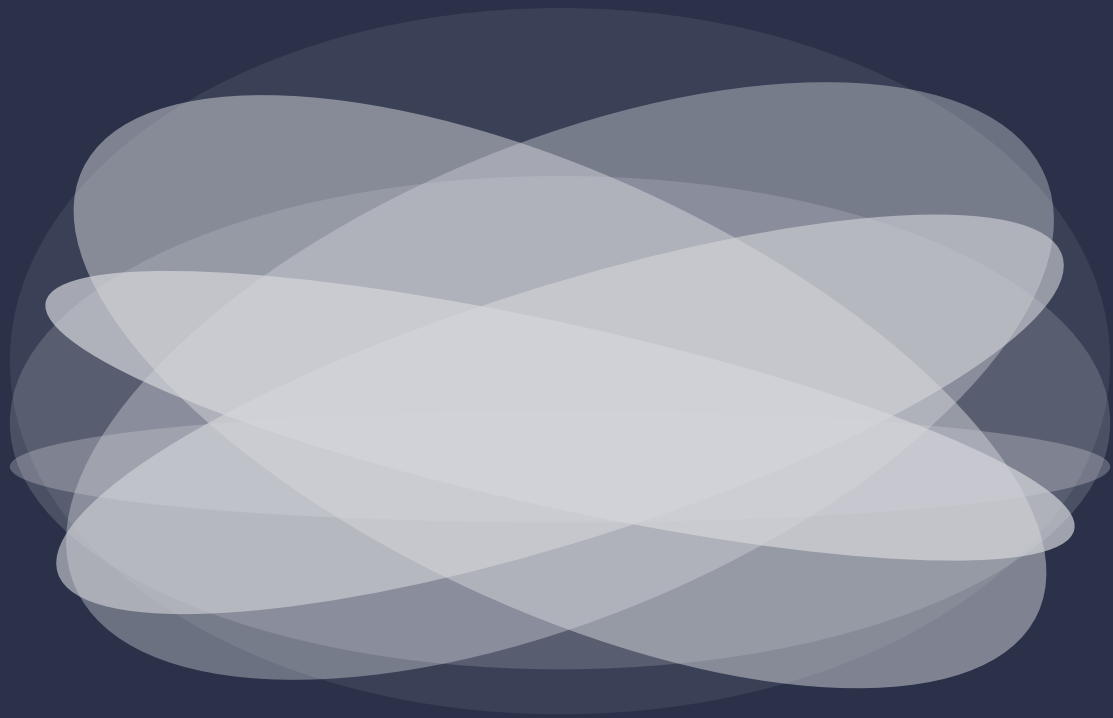

WELIGHTING



WELIGHTING

Illumination serves more than the obvious purpose of providing visibility – it can also set an ambiance, establish a mood and even alter perception. Good lighting design strikes the perfect balance between aesthetics and technology to reimagine any space into something extraordinary.

Our team of professional are dedicated to supporting your interior design project from start to finish. Our specialists provide thoughtful style consultation and source the latest in-trend lighting fixtures, as well as create custom luminaires based on technical reports. Throughout the entire process, our experts strive for excellence providing comprehensive test and commissioning support along the way.

WE Mission

WE strive to provide the best lighting product and service every step of your project, as the WE success is built on the relentless commitment to satisfy our customers.

WE Value

WE perfect every area of our lighting solution service. WE believe that never-ending innovation is the cornerstone of our daily work.



QUALITY

To ensure that we deliver the best possible services, our R&D team is dedicated to providing you with a high standard of technical knowledge. They are responsible for new technology investigation and development as well as sourcing components from reputable suppliers in order to make sure all projects run smoothly without any hiccups along their journey.



CUSTOM-MADE

A stylish design goes beyond the visual appeal of a space. It's also about the comfort and quality experience a space offers to its users. No matter whether you are seeking to save energy, maximize comfort, or get a personalized scene that can be transformed at the flick of a switch, we tailor-make lighting control solutions for homes, stores, offices, or even outdoor spaces.

SHOWROOM

WE showroom and office locate in Lai Chi Kok, and we will have regular event and seminar for technical presentation as well as leisure gathering. WE sincerely invite you to visit our showroom anytime.

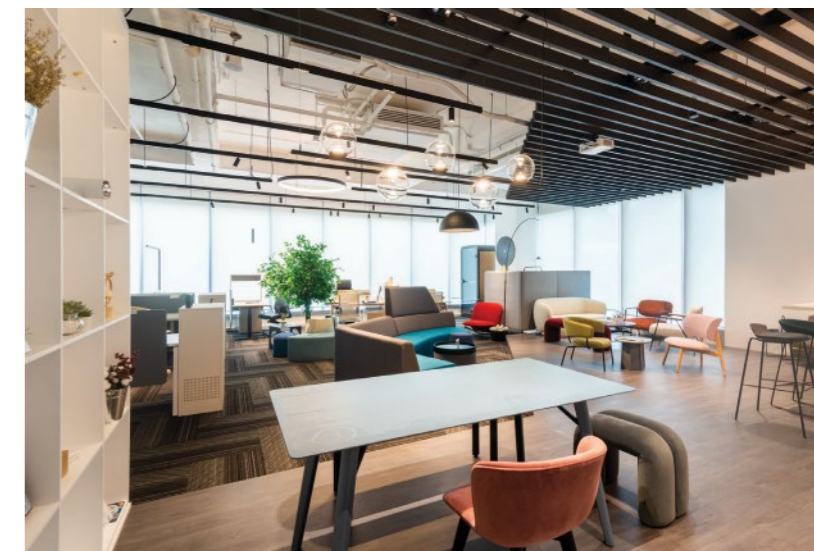

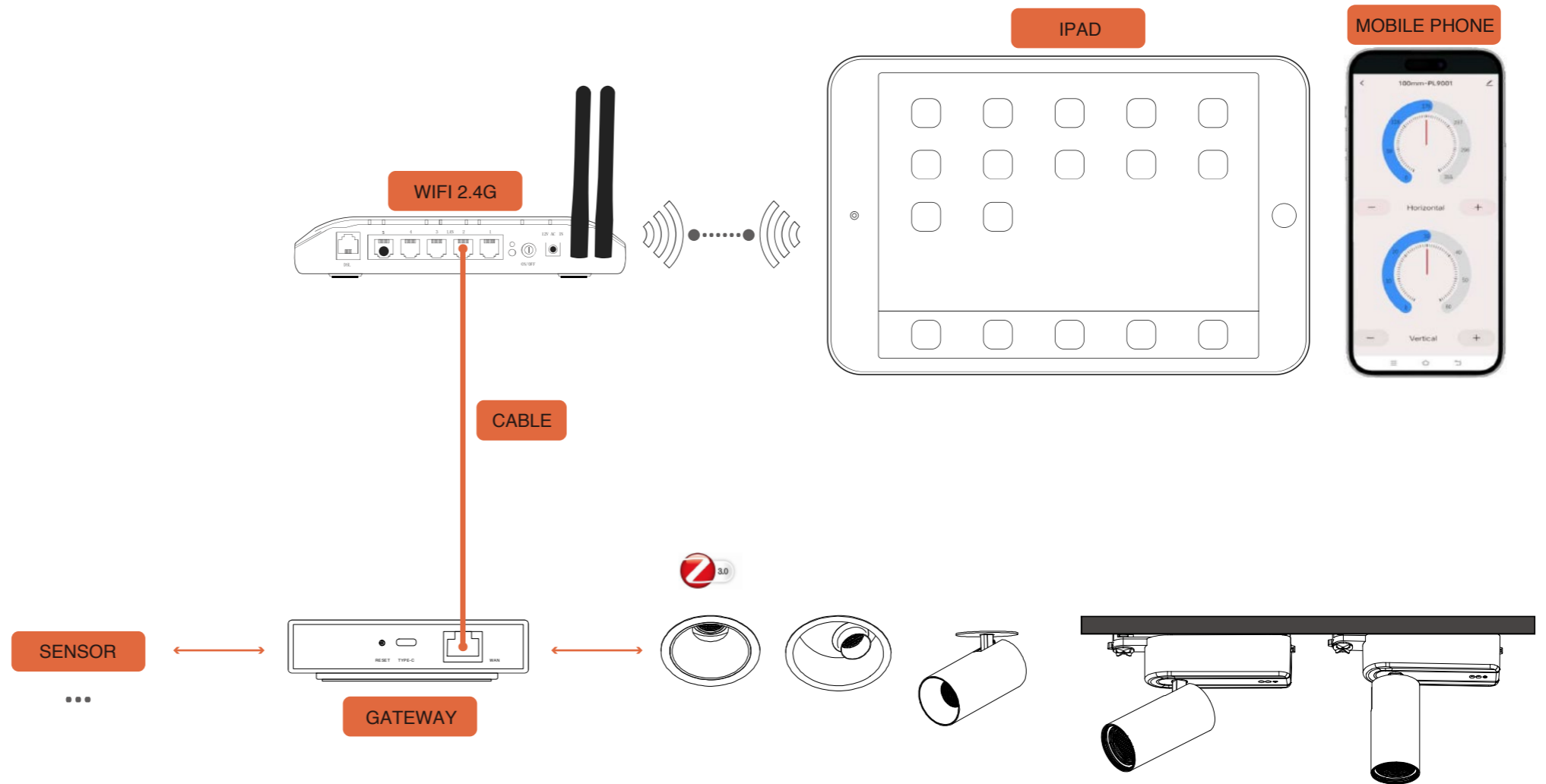

Wireless Connection

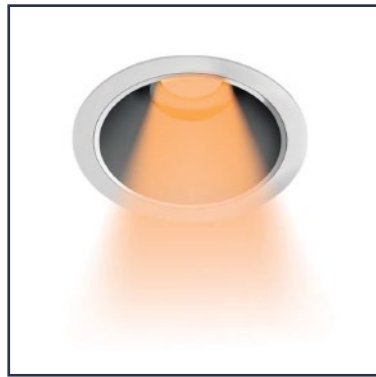

PAVEL ST P10

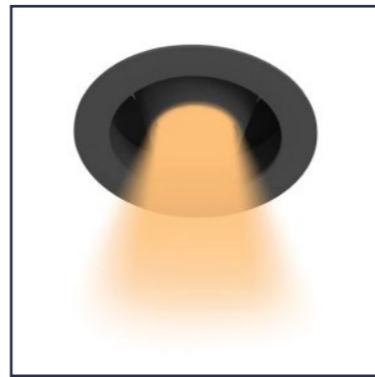

PAVEL N P12



PAVEL SP P14



PAVEL TR P15



PAVEL TRM P16



PAVEL ST

- Die-cast aluminum trim
- Black anti-glare tube
- Motorized and zoomable option
- Protocol option: ZigBee, Tuya, DMX512, Casambi
- Remote drive, separated order



MOTORIZED

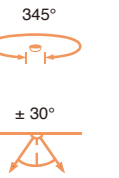

WE PL31601 -

Angle - 90° - Color

Beam Angle	Fixed CCT	Color
0 7 07°	2 7 2700K	W W White Trim, White Reflector
1 6 16°	3 0 3000K	W B White Trim, Black Reflector
2 5 25°	4 0 4000K	B B Black Trim, Black Reflector
4 0 40°	2 7 4 0 2700K-4000K Tunable White	

COB Max.7.2W 200mA 900lm (Mono White)

COB Max.10.8W 300mA 1350lm (Tunable White)

Ø75mm

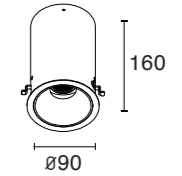

WE PL31602 -

Angle - 90° - Color

Beam Angle	Fixed CCT	Color
1 0 10°	2 7 2700K	W W White Trim, White Reflector
1 6 16°	3 0 3000K	W B White Trim, Black Reflector
2 5 25°	4 0 4000K	B B Black Trim, Black Reflector
4 0 40°	2 7 4 0 2700K-4000K Tunable White	

COB Max.14.4W 400mA 1800lm (Mono White)

COB Max.19.8W 550mA 2475lm (Tunable White)

Ø100mm

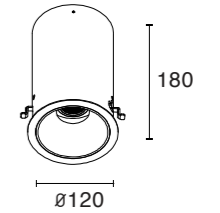

WE PL31603 -

Angle - 90° - Color

Beam Angle	Fixed CCT	Color
0 8 08°	2 7 2700K	W W White Trim, White Reflector
1 0 10°	3 0 3000K	W B White Trim, Black Reflector
1 6 16°	4 0 4000K	B B Black Trim, Black Reflector
2 5 25°	1 8 4 0 1800K-4000K Tunable White	
4 0 40°	2 7 6 0 2700K-6000K Tunable White	
1 5 5 5 15°-55° Zoomable		

COB Max.25.2W 700mA 3150lm (Mono White)

COB Max.28.8W 800mA 3600lm (Tunable White)

Ø150mm

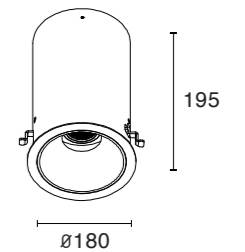



PAVEL N

- Die-cast aluminum trim
- Black anti-glare tube
- Motorized and zoomable option
- Protocol option: ZigBee, Tuya, DMX512, Casambi
- Remote drive, separated order

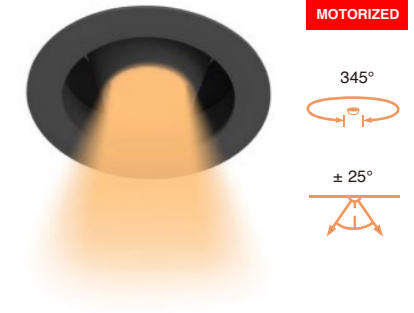

WE PL31604 - Angle - CRI - CCT - Color

Beam Angle	Fixed CCT	Color
0 7 07°	2 7 2700K	W W White Trim , White Body
1 6 16°	3 0 3000K	B B Black Trim , Black Body
2 5 25°	4 0 4000K	
4 0 40°	2 7 4 0 2700K-4000K Tunable White	

- COB Max.7.2W 200mA 900lm (Mono White)
- COB Max.10.8W 300mA 1350lm (Tunable White)

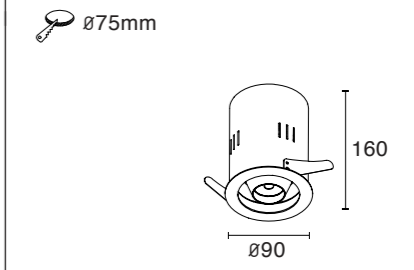

WE PL31605 - Angle - CRI - CCT - Color

Beam Angle	Fixed CCT	Color
1 0 10°	2 7 2700K	W W White Trim , White Body
1 6 16°	3 0 3000K	B B Black Trim , Black Body
2 5 25°	4 0 4000K	
4 0 40°	2 7 4 0 2700K-4000K Tunable White	

- COB Max.14.4W 400mA 1800lm (Mono White)
- COB Max.19.8W 550mA 2475lm (Tunable White)

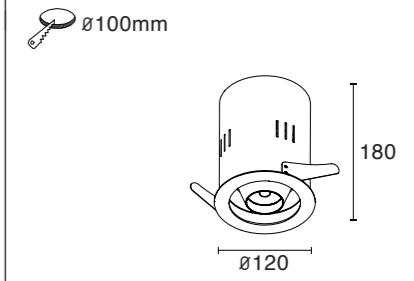

WE PL31606 - Angle - CRI - CCT - Color

Beam Angle	Fixed CCT	Color
0 8 08°	2 7 2700K	W W White Trim , White Body
1 0 10°	3 0 3000K	B B Black Trim , Black Body
1 6 16°	4 0 4000K	
2 5 25°	1 8 4 0 1800K-4000K Tunable White	
4 0 40°	2 7 6 0 2700K-6000K Tunable White	
1 5 5 5 15°-55° Zoomable		

- COB Max.25.2W 700mA 3150lm (Mono White)
- COB Max.28.8W 800mA 3600lm (Tunable White)

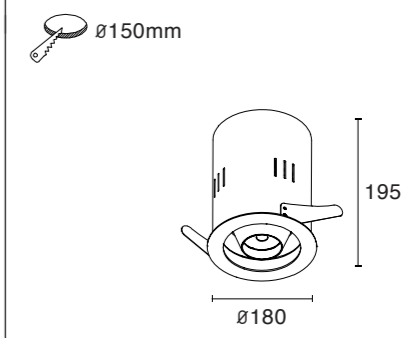

Motorized Remote Controlled Lighting

PAVEL SP

- Recessed-mounted light, metal body
- Black anti-glare tube
- Motorized and zoomable option
- Protocol option: ZigBee, Tuya, DMX512, Casambi
- Remote drive, separated order



WE PL31607 - Angle - 90 - CCT - Color

Beam Angle	Fixed CCT	Color
1 0 10°	2 7 2700K	W W White Body
1 6 16°	3 0 3000K	B B Black Body
2 5 25°	4 0 4000K	
4 0 40°	2 7 6 0 2700K-6000K Tunable White	

- COB Max.10.8W 300mA 1350lm (Mono White)
- COB Max.18W 500mA 2250lm (Tunable White)

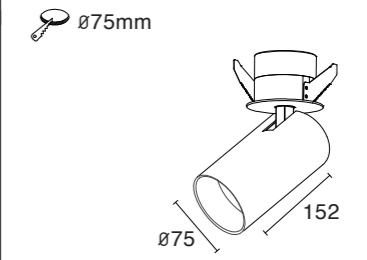

WE PL31608 - Angle - 90 - CCT - Color

Beam Angle	Fixed CCT	Color
1 0 10°	2 7 2700K	W W White Body
1 6 16°	3 0 3000K	B B Black Body
2 5 25°	4 0 4000K	
4 0 40°	2 7 6 0 2700K-6000K Tunable White	

- COB Max.21.6W 600mA 2700lm (Mono White)
- COB Max.27W 750mA 3375lm (Tunable White)

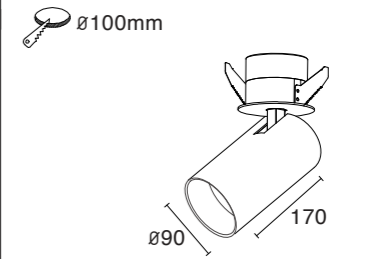

WE PL31609 - Angle - 90 - CCT - Color

Beam Angle	Fixed CCT	Color
0 8 08°	2 7 2700K	W W White Body
1 0 10°	3 0 3000K	B B Black Body
1 6 16°	4 0 4000K	
2 5 25°	1 8 4 0 1800K-4000K Tunable White	
4 0 40°	2 7 6 0 2700K-6000K Tunable White	
1 5 5 5 15°-55° Zoomable		

- COB Max.28.8W 800mA 3600lm (Mono White)
- COB Max.34.2W 950mA 4275lm (Tunable White)

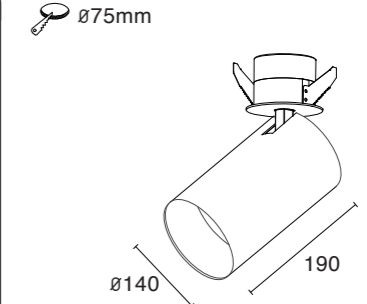

PAVEL TR

- Three phase track adapted, metal body
- Black anti-glare tube
- Motorized and zoomable option
- Protocol option: ZigBee, Tuya, DMX512, Casambi
- Remote drive, separated order



MOTORIZED



WE PL41191 - Angle - CRI - CCT - Color

Beam Angle	Fixed CCT	Color
1 0 10°	2 7 2700K	W W White Body , White Glare Tube
1 6 16°	3 0 3000K	W B White Body , Black Glare Tube
2 5 25°	4 0 4000K	B B Black Body , Black Glare Tube
4 0 40°	2 7 6 0 2700K-6000K Tunable White	

- COB Max.10.8W 300mA 1350lm (Mono White)
- COB Max.18W 500mA 2250lm (Tunable White)

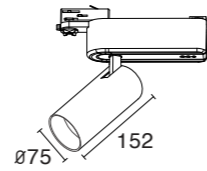

WE PL41192 - Angle - CRI - CCT - Color

Beam Angle	Fixed CCT	Color
1 0 10°	2 7 2700K	W W White Body , White Glare Tube
1 6 16°	3 0 3000K	W B White Body , Black Glare Tube
2 5 25°	4 0 4000K	B B Black Body , Black Glare Tube
4 0 40°	2 7 6 0 2700K-6000K Tunable White	

- COB Max.21.6W 600mA 2700lm (Mono White)
- COB Max.27W 750mA 3375lm (Tunable White)

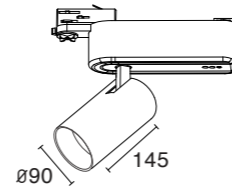

WE PL41193 - Angle - CRI - CCT - Color

Beam Angle	Fixed CCT	Color
0 8 08°	2 7 2700K	W W White Body , White Glare Tube
1 0 10°	3 0 3000K	W B White Body , Black Glare Tube
1 6 16°	4 0 4000K	B B Black Body , Black Glare Tube
2 5 25°	1 8 4 0 1800K-4000K Tunable White	
4 0 40°	2 7 6 0 2700K-6000K Tunable White	
1 5 5 5 15°-55° Zoomable		

- COB Max.28.8W 800mA 3600lm (Mono White)
- COB Max.34.2W 950mA 4275lm (Tunable White)

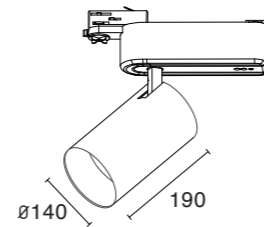

PAVEL TRM

- Three phase track adapted, metal body
- Black anti-glare tube
- Motorized and zoomable option
- Protocol option: ZigBee, Tuya, DMX512, Casambi
- Remote drive, separated order

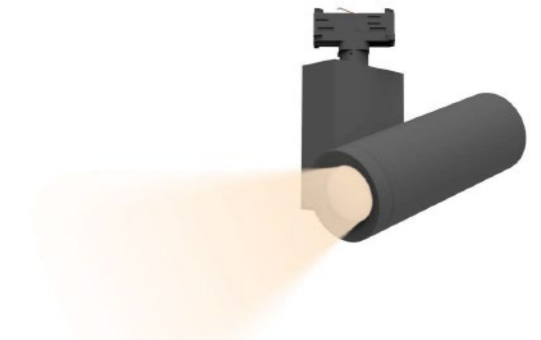

MOTORIZED



WE PL41194 - Angle - CRI - CCT - Color

Beam Angle	Fixed CCT	Color
1 0 10°	2 7 2700K	W W White Body , White Glare Tube
1 6 16°	3 0 3000K	W B White Body , Black Glare Tube
2 5 25°	4 0 4000K	B B Black Body , Black Glare Tube
4 0 40°	2 7 6 0 2700K-6000K Tunable White	

- COB Max.10.8W 300mA 1350lm (Mono White)
- COB Max.19.8W 550mA 2475lm (Tunable White)

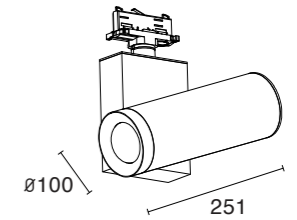

WE PL41195 - Angle - CRI - CCT - Color

Beam Angle	Fixed CCT	Color
1 0 10°	2 7 2700K	W W White Body , White Glare Tube
1 6 16°	3 0 3000K	W B White Body , Black Glare Tube
2 5 25°	4 0 4000K	B B Black Body , Black Glare Tube
4 0 40°	2 7 6 0 2700K-6000K Tunable White	

- COB Max.25.2W 700mA 3150lm (Mono White)
- COB Max.28.8W 800mA 3600lm (Tunable White)

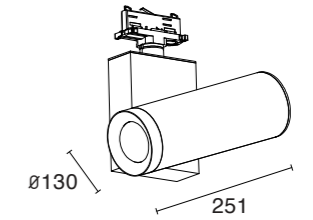

WE PL41196 - Angle - CRI - CCT - Color

Beam Angle	Fixed CCT	Color
0 8 08°	2 7 2700K	W W White Body , White Glare Tube
1 0 10°	3 0 3000K	W B White Body , Black Glare Tube
1 6 16°	4 0 4000K	B B Black Body , Black Glare Tube
2 5 25°	1 8 4 0 1800K-4000K Tunable White	
4 0 40°	2 7 6 0 2700K-6000K Tunable White	
1 2 3 5 12°-35° Zoomable		
1 5 5 5 15°-55° Zoomable		

- COB Max.36W 1000mA 4500lm (Mono White & Tunable White)

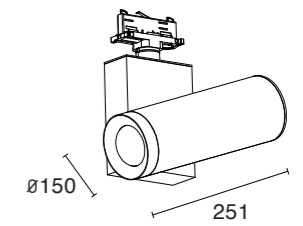



www.welighting.com



WELIGHTING



+852 2359 9866



mail@welighting.com



Unit 01-07, 22/F, CEO Tower,
77 Wing Hong Street, Lai Chi Kok, Hong Kong

WELIGHTING
www.welighting.com

© 2024 We Lighting Ltd. All rights reserved.